

Stichting Edibulb

Logistieke Order bericht “Edibulb Standaard XML”

Berichtdefinitie

Versie 1.0

Definitief

Copyright © 2010 Stichting Edibulb

Wijzigingsblad

Datum laatste revisie: donderdag 9 december 2010

Bestandsnaam : RT637v1.0 EBL berichtdefinitie logistiek.doc

Bestandsnummer : RT637v1.0

Versie	Auteur(s)	Wijzigingen
0.01	Ron Touw	Initiële versie
0.02	Ron Touw	Na verwerken opmerkingen H. van Rossen
0.03	Ron Touw	Na overleg softwareleveranciers 24-06-2008
0.04	Ron Touw	Correcties
1.0	Hans van Rossen	Definitieve versie na toevoeging palletDetails.

	Datum	Functionaris	Paraaf
Akkoord		Ron Touw (Auteur)	
Gecontroleerd		Hans van Rossen (Agritect Advies B.V.)	
Geaccepteerd namens Projectgroep Edibulb		Henk Zwinkels (Projectleider)	
Geaccepteerd namens Stichting Edibulb		_____ (Opdrachtgever)	

Stichting Edibulb Confidentieel

Dit document en de intellectuele inhoud ervan zijn eigendom van Stichting Edibulb p/a te Waddinxveen, en mogen op geen enkele wijze worden vermenigvuldigd en/of kenbaar worden gemaakt aan derden, voor welk doel dan ook, zonder de schriftelijke toestemming van de eigenaresse.

Inhoud

1	INLEIDING	5
1.1	Doel van dit document	5
1.2	Bestemd voor...	5
1.3	Uitgangspunten	5
1.4	Afkortingen en begrippen	5
2	DEFINITIE	6
2.1	Orderen (logistiek)	6
2.1.1	Fustbestelling (bevestiging)	6
2.1.2	Transportopdracht product (bevestiging)	6
2.1.3	Levering fust	6
2.1.4	Factuur	7
3	APPLICATIE	8
3.1	Logistieke order bericht	8
3.1.1	Berichtstructuur logistiekeOrder	8
3.1.2	Gebruikte componenten	10
3.1.3	Berichtafspraken logistiekeOrder	10
3.1.3.1	Element logistiekeOrder/header	10
3.1.3.2	Element logistiekeOrder/orderedBy	11
3.1.3.3	Element logistiekeOrder/consignee	15
3.1.3.4	Element logistiekeOrder/consignor	19
3.1.3.5	Element logistiekeOrder/carrier	23
3.1.3.6	Element logistiekeOrder/freightPayer	26
3.1.3.7	Element logistiekeOrder/freetext	30
3.1.3.8	Element logistiekeOrder/lineltemDetails	30
3.1.3.8.1	Element logistiekeOrder/lineltemDetails/transportUnits	36
3.1.3.8.1.1	Element logistiekeOrder/lineltemDetails/transportUnits/packing	36
3.1.4	Beveiliging	42
3.2	Error Bericht	42
3.2.1	Gebruikte componenten	42
3.2.2	Berichtstructuur error	42
3.2.3	Berichtafspraken error	42
3.2.3.1	Element Errorlist/Error	43
3.2.4	Beveiliging	43
3.3	Acknowledge Bericht	43
3.3.1	Gebruikte componenten	43
3.3.2	Berichtstructuur acknowledge	43
3.3.3	Berichtafspraken acknowledge	43
3.3.4	Beveiliging	43
4	TRANSPORT	44
4.1	Pilot	44

4.2	Invulinstructie SOAP Envelop	44
4.2.1	SOAP Header	44
4.2.1.1	ebXML messageheader	44
4.2.1.2	ebXML error	45
4.2.2	SOAP Body	45
4.2.2.1	ebXML manifest	45
4.3	Beveiliging	46
5	NETWERK	47
6	BIJLAGEN	48
6.1	Invulinstructie	48
6.2	Voorbeeld fust bestelopdracht	49
6.3	Voorbeeld voorlopige goederen transportopdracht	51
6.4	Voorbeeld definitieve goederen transportopdracht	54
6.4.1	Standaard	54
6.4.2	Voorbeelden detaillering definitieve goederen transportopdracht	57
6.4.2.1	Voorbeeld 1 - Basis	57
6.4.2.2	Voorbeeld 2 - Met ladingdrager identificatie	59
6.4.2.3	Voorbeeld 3 - Met fustspecificatie	61
6.4.2.4	Voorbeeld 4 - Met individuele fust identificatie	64
6.5	Voorbeeld fust levering	68

1 Inleiding

1.1 Doel van dit document

Dit document beschrijft de Edibulb ebXML standaard voor de Elektronische Logistieke Order berichten.

In hoofdstuk 3 wordt het bericht op applicatieniveau gespecificeerd zoals deze zal worden opgenomen als body van het uiteindelijke bericht.

Hoofdstuk 4 beschrijft de transportlaag volgens ebXML. Het specificeert de invulling van de SOAP en ebXML headers t.b.v. de order berichten.

Ten slotte wordt in hoofdstuk 5 het netwerkmedium gespecificeerd waarover de communicatie zal plaatsvinden.

Elk specificerend hoofdstuk zal ook de toe te passen beveiliging beschrijven.

1.2 Bestemd voor...

Dit document is bestemd voor alle partijen binnen de bollensector die op elektronische wijze de orders willen uitwisselen en voor organisaties die zich bezighouden met de ontwikkeling van softwaretoepassingen hiervoor.

1.3 Uitgangspunten

Dit document is gebaseerd op:

- 'ebXML standaard' volgens www.ebxml.org
- 'Modulen, Blokken en Componenten' van het project DataTuin
- 'Standaard systematiek voor de logistiek in de bloembollensector' van het XML project Edibulb.

Voor de Berichtdefinitie worden de volgende uitgangspunten gehanteerd:

- Er wordt enkel gebruik gemaakt van informatieblokken zoals deze zijn gedefinieerd in de "DataTuin" Module/Component/Blok definitie welke zijn opgesteld in lijn met het ebXML ontwerp.

1.4 Afkortingen en begrippen

Afkorting/begrip	Omschrijving
XML	eXtended Markup Language

2 Definitie

2.1 Orderen (logistiek)

In de bloembollensector vindt intensief berichtenverkeer plaats tussen verkopers, kopers en bemiddelaars van bloembollen. In de volgende paragrafen zijn de logistieke berichten die tussen deze partijen worden uitgewisseld beschreven.

2.1.1 Fustbestelling (bevestiging)

Met de fustbestelling (FB) geeft de opdrachtgever aan de vervoerder door welk fust wanneer en waar moet worden opgehaald en wanneer en waar moet worden afgeleverd. Voor het genereren van het bericht wordt als basis een afgesloten order gebruikt (referentie).

De opdrachtgever kan aangeven wie de ontvanger is, wie het transport uitvoert en wie het transport gaat betalen. Het bericht is voor de vervoerder de invoer van zijn planning.

De bevestiging (FBB) wordt door de vervoerder naar de opdrachtgever verstuurd zodra deze de bestelling heeft verwerkt. De vervoerder kan de bestelling annuleren, wijzigen, accepteren of niet accepteren. De vervoerder kan de bevestiging ook naar een fustbeheerder sturen wanneer hij het fust niet op voorraad heeft.

2.1.2 Transportopdracht product (bevestiging)

Dit bericht wordt door de opdrachtgever verstuurd wanneer goederen van de ene lokatie naar de andere lokatie moeten worden gebracht. Er zijn twee typen berichten: de voorlopige transportopdracht (VTO) en de definitieve transportopdracht (DTO). De voorlopige opdracht wordt verstuurd om de vervoerder de gelegenheid te geven zijn planning te maken. De definitieve opdracht is de 'echte' opdracht. De opdrachten bevatten gegevens over de hoeveelheid en soort van de te transporteren goederen, de lokatie waar en wanneer het product moet worden opgehaald en waar en wanneer het product moet worden afgeleverd.

Voor het genereren van de berichten wordt als basis een afgesloten order gebruikt (referentie).

De bevestiging (VTB of DTB) wordt door de vervoerder naar de opdrachtgever en de ontvanger van de goederen (consignee) verstuurd. De vervoerder kan de transportopdracht annuleren, wijzigen, accepteren of niet accepteren.

2.1.3 Levering fust

Dit bericht vergezelt de fysieke goederenstroom (fustzending). Het bericht wordt door de vervoerder naar de opdrachtgever en de ontvanger van het fust (consignee) verstuurd wanneer hij de fustbestelling uitvoert. Het bericht wordt door de fustbeheerder (de verzender van het fust (consignor) verstuurd wanneer deze de bestelling uitvoert, b.v. omdat de vervoerder het betreffende fust niet heeft. Een transportopdracht kan in meerdere zendingen worden uitgevoerd. Bij elke zending wordt aangegeven wat reeds is afgeleverd, wat wordt afgeleverd en wat nog gaat worden afgeleverd (indien van toepassing).

2.1.4 Factuur

In dit bericht wordt vanaf de zijde van de vervoerder aan de betaler van het transport de factuurgegevens gestuurd. Het berichtformaat van dit bericht komt overeen met het berichtformaat van de commerciële factuur.

3 Applicatie

De hier behandelde berichten betreffen het fustbestel(bevestiging), het fusttransport (bevestiging), het producttransport(bevestiging) (voorlopig en definitief) en het fustlever bericht. Al deze berichten zijn gebaseerd op de layout van het 'logistieke order bericht'.

3.1 Logistieke order bericht

Het 'logistieke order bericht' bevat alle velden die nodig zijn voor de diverse eerder genoemde berichten. Afhankelijk van het documenttype zijn velden in het algemene bericht wel of niet relevant en ingevuld.

Versie	Toelichting	Schema
1.00	Initiële versie	http://www.edibulb.nl/XML/Logistiek/Logistiekeorder-1_00.xsd

3.1.1 Berichtstructuur logistiekeOrder

Het rootelement order kent een attribuut 'function' waarin de onderstaande berichtfunctie kan worden meegegeven:

Berichtfunctie (M, an..3)

1	Cancel
3	Deletion
4	Change
5	Replace
9	Original
27	Not accepted
29	Accepted

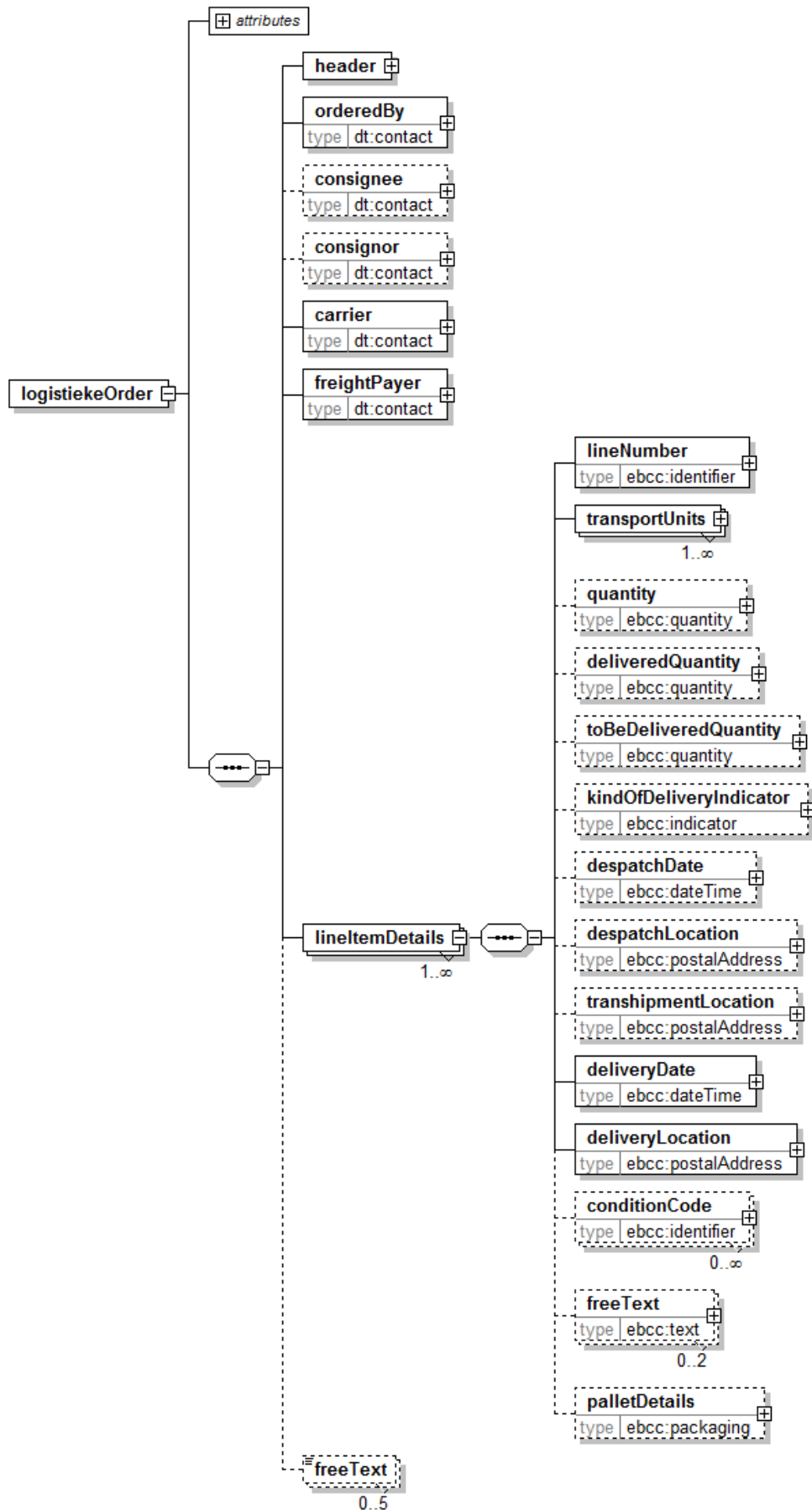

3.1.2 Gebruikte componenten

Module	Bron	Referentie	V/O*
header	logistiekeOrder Component	dit document	V
orderedBy	logistiekeOrder Component	dit document	V
consignee	logistiekeOrder Component	dit document	O
consignor	logistiekeOrder Component	dit document	O
carrier	logistiekeOrder Component	dit document	V
freightPayer	logistiekeOrder Component	dit document	V
lineItemDetails	logistiekeOrder Component	dit document	V

De met V aangemerkte modules zijn verplicht in te vullen, de met O aangemerkte modules zijn optioneel.

3.1.3 Berichtafspraken logistiekeOrder

3.1.3.1 Element logistiekeOrder/header

Element t.b.v. het uniek identificeren van het bericht.

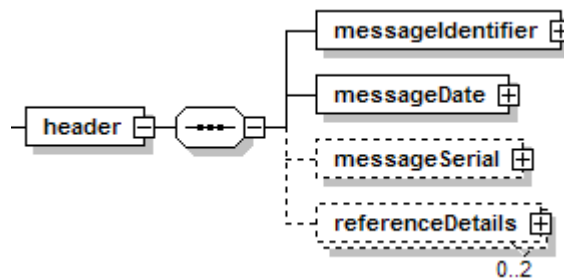

Element	Waarde
messageIdentifier	<p>Element voor het opgeven van de logistiekeOrder identificatie. Als Agency wordt het Edibulb NAW nummer opgegeven van de betrokken 'generator' van het bericht. schemeversion=Versie logistiekeOrder (LON10) schemelidentier geeft het type bericht aan: FB = Fustbestelling FBB = Fustbestelling bevestiging VTO = Transportopdracht product (voorlopig) VTB = Transportopdracht product (voorlopig) bevestiging DTO = Transportopdracht product (definitief) DTB = Transportopdracht product (definitief) bevestiging FL = Fustlevering</p> <pre> <messageIdentifier> <ebcc:content>an..10</ebcc:content> <ebcc:schemelidentier>an..3</ebcc:schemelidentier> <ebcc:schemeNameText>NG</ebcc:schemeNameText> <ebcc:schemeAgencyIdentifier>n5</ebcc:schemeAgencyIdentifier> <ebcc:schemeAgencyNameText>NG</ebcc:schemeAgencyNameText> <ebcc:schemeVersionIdentifier>LON10</ebcc:schemeVersionIdentifier> <ebcc:schemeDataUniformResourceIdentifier>NG </ebcc:schemeDataUniformResourceIdentifier> <ebcc:schemeUniformResourceIdentifier>NG</ebcc:schemeUniformResourceIdentifier> </messageIdentifier> </pre> <pre> <messageIdentifier> <ebcc:content>0003046565</ebcc:content> <ebcc:schemelidentier>FB</ebcc:schemelidentier> <ebcc:schemeAgencyIdentifier>10253</ebcc:schemeAgencyIdentifier> <ebcc:schemeVersionIdentifier>LON10</ebcc:schemeVersionIdentifier> </messageIdentifier> </pre>

messageDate	<p>Datum waarop de order waarop deze berichten zijn gebaseerd is afgesloten.</p> <pre><messageDate> <ebcc:content>CCYYMMDD</ebcc:content> <ebcc:formatText>102</ebcc:formatText> </messageDate> <orderDate> <ebcc:content>20030101</ebcc:content><ebcc:formatText>102</ebcc:formatText> </orderDate></pre>
messageSerial	<p>Bericht volgnummer. Wordt 1 keer gebruikt. In dit segment wordt het eventuele volgnummer van de logistiekeOrder vermeld.</p> <pre><messageSerial> <ebcc:content>n..2</ebcc:content><ebcc:formatText>NG</ebcc:formatText> </messageSerial> <messageSerial><ebcc:content>1</ebcc:content></messageSerial></pre>
referenceDetails	<p>Referentie naar het berichtnummer (messageIdentifier) van een logistiekeOrder met schema=LON, Agency=NAW van uitschrijvende organisatie, Schemaversion=Versie logistiekeOrder (optioneel).</p> <pre><referenceDetails> <dt:referencelIdentifier> <ebcc:content>an..10</ebcc:content> <ebcc:schemelIdentifier>an..3</ebcc:schemelIdentifier> <ebcc:schemeNameText>NG</ebcc:schemeNameText> <ebcc:schemeAgencyIdentifier>n5</ebcc:schemeAgencyIdentifier> <ebcc:schemeAgencyNameText>NG</ebcc:schemeAgencyNameText> <ebcc:schemeVersionIdentifier>LON10</ebcc:schemeVersionIdentifier> <ebcc:schemeDataUniformResourceIdentifier>NG </ebcc:schemeDataUniformResourceIdentifier> <ebcc:schemeUniformResourceIdentifier>NG </ebcc:schemeUniformResourceIdentifier> </dt:referencelIdentifier> <dt:lineNumber> <ebcc:content>NG</ebcc:content><ebcc:formatText>NG</ebcc:formatText> </dt:lineNumber> </referenceDetails> <referenceDetails> <dt:referencelIdentifier> <ebcc:content>0003046564</ebcc:content> <ebcc:schemelIdentifier>FB</ebcc:schemelIdentifier> <ebcc:schemeAgencyIdentifier>10253</ebcc:schemeAgencyIdentifier> <ebcc:schemeVersionIdentifier>LON10</ebcc:schemeVersionIdentifier> </dt:referencelIdentifier> </referenceDetails></pre>

3.1.3.2 Element logistiekeOrder/orderedBy

Element t.b.v. het uniek identificeren van de opdrachtgever.

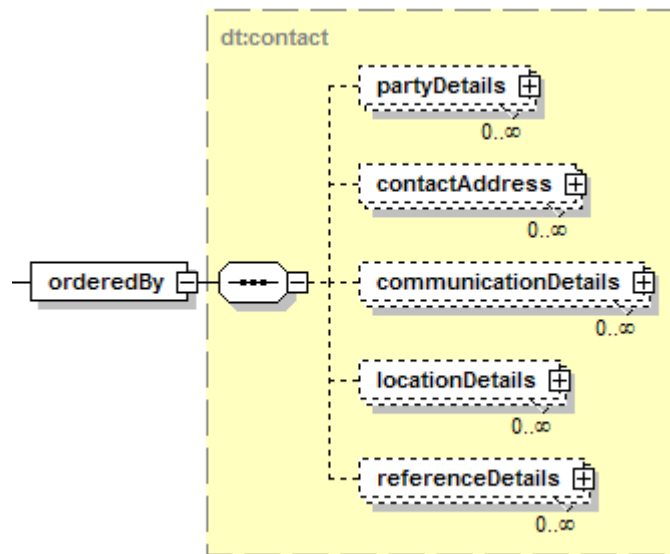

Element	Waarde
partyDetails (1)	<p>Unieke identificatie van de opdrachtgever middels Edibulb NAW code en type OB. Tevens identificatie contactpersoon.</p> <pre> <dt:partyDetails> <ebcc:identifier> <ebcc:content>n5</ebcc:content> <ebcc:schemelIdentifier>NG</ebcc:schemelIdentifier> <ebcc:schemeNameText>NG</ebcc:schemeNameText> <ebcc:schemeAgencyIdentifier>NG</ebcc:schemeAgencyIdentifier> <ebcc:schemeAgencyNameText>NG</ebcc:schemeAgencyNameText> <ebcc:schemeVersionIdentifier>NG</ebcc:schemeVersionIdentifier> <ebcc:schemeDataUniformResourceIdentifier>NG </ebcc:schemeDataUniformResourceIdentifier> <ebcc:schemeUniformResourceIdentifier>NG </ebcc:schemeUniformResourceIdentifier> </ebcc:identifier> <ebcc:descriptionText> <ebcc:content>NG</ebcc:content> <ebcc:languageIdentifier>NG</ebcc:languageIdentifier> <ebcc:languageLocaleIdentifier>NG</ebcc:languageLocaleIdentifier> </ebcc:descriptionText> <ebcc:typeCode> <ebcc:content>OB</ebcc:content> <ebcc:listIdentifier>NG</ebcc:listIdentifier> <ebcc:listAgencyIdentifier>NG</ebcc:listAgencyIdentifier> <ebcc:listAgencyNameText>NG</ebcc:listAgencyNameText> <ebcc:listNameText>NG</ebcc:listNameText> <ebcc:listVersionIdentifier>NG</ebcc:listVersionIdentifier> <ebcc:nameText>NG</ebcc:nameText> <ebcc:languageIdentifier>NG</ebcc:languageIdentifier> <ebcc:listUniformResourceIdentifier>NG</ebcc:listUniformResourceIdentifier> <ebcc:listSchemeUniformResourceIdentifier>NG </ebcc:listSchemeUniformResourceIdentifier> </ebcc:typeCode> <ebcc:personDetails> <ebcc:name> <ebcc:content>an..36</ebcc:content> <ebcc:languageIdentifier>NG</ebcc:languageIdentifier> <ebcc:languageLocaleIdentifier>NG</ebcc:languageLocaleIdentifier> </ebcc:name> <ebcc:taxIdentifier>NG</ebcc:taxIdentifier> <ebcc:birthDate>NG</ebcc:birthDate> <ebcc:givenName> <ebcc:content>an..12</ebcc:content> <ebcc:languageIdentifier>NG</ebcc:languageIdentifier> <ebcc:languageLocaleIdentifier>NG</ebcc:languageLocaleIdentifier> </ebcc:givenName> </ebcc:personDetails> </dt:partyDetails> </pre>

	<pre> <ebcc:middleName>NG</ebcc:middleName> <ebcc:surName> <ebcc:content>an.24</ebcc:content> <ebcc:languageIdentifier>NG</ebcc:languageIdentifier> <ebcc:languageLocaleIdentifier>NG</ebcc:languageLocaleIdentifier> </ebcc:surName> <ebcc:genderCode>NG</ebcc:genderCode> <ebcc:nationalityCode>NG</ebcc:nationalityCode> <ebcc:namePrefixCode>NG</ebcc:namePrefixCode> <ebcc:nameSuffixCode>NG</ebcc:nameSuffixCode> </ebcc:personDetails> <ebcc:organisationDetails>NG</ebcc:organisationDetails> </dt:partyDetails> </pre>
	<pre> < dt:partyDetails> <ebcc:identifier><ebcc:content>09370</ebcc:content></ebcc:identifier> <ebcc:typeCode><ebcc:content>OB</ebcc:content></ebcc:typeCode> </ dt:partyDetails> </pre>
contactAddress	<p>Opgave van Straatnaam of 'Postbus', Vervolg straatnaam, huisnummer of postbusnummer, (woon)plaats, Postcode en Code van het land van vestiging (C, an..3). Zie EDIBULB codelijst Land, www.edibulb.nl.</p> <pre> <dt:contactAddress> <ebcc:typeCode>NG</ebcc:typeCode> <ebcc:streetBuildingIdentifier> <ebcc:content>an..8</ebcc:content> <ebcc:schemelIdentifier>NG</ebcc:schemelIdentifier> <ebcc:schemeNameText>NG</ebcc:schemeNameText> <ebcc:schemeAgencyIdentifier>NG</ebcc:schemeAgencyIdentifier> <ebcc:schemeAgencyNameText>NG</ebcc:schemeAgencyNameText> <ebcc:schemeVersionIdentifier>NG</ebcc:schemeVersionIdentifier> <ebcc:schemeDataUniformResourceIdentifier>NG </ebcc:schemeDataUniformResourceIdentifier> <ebcc:schemeUniformResourceIdentifier>NG</ebcc:schemeUniformResourceIdentifier> </ebcc:streetBuildingIdentifier> <ebcc:streetName> <ebcc:content>an..43</ebcc:content> <ebcc:languageIdentifier>NG</ebcc:languageIdentifier> <ebcc:languageLocaleIdentifier>NG</ebcc:languageLocaleIdentifier> </ebcc:streetName> <ebcc:districtName> NG </ebcc:districtName> <ebcc:townName> <ebcc:content>an..24</ebcc:content> <ebcc:languageIdentifier>NG</ebcc:languageIdentifier> <ebcc:languageLocaleIdentifier>NG</ebcc:languageLocaleIdentifier> </ebcc:townName> <ebcc:stateIdentifier>NG</ebcc:stateIdentifier> <ebcc:postCodeIdentifier> <ebcc:content>an..9</ebcc:content> <ebcc:schemelIdentifier>NG</ebcc:schemelIdentifier> <ebcc:schemeNameText>NG</ebcc:schemeNameText> <ebcc:schemeAgencyIdentifier>NG</ebcc:schemeAgencyIdentifier> <ebcc:schemeAgencyNameText>NG</ebcc:schemeAgencyNameText> <ebcc:schemeVersionIdentifier>NG</ebcc:schemeVersionIdentifier> <ebcc:schemeDataUniformResourceIdentifier>NG </ebcc:schemeDataUniformResourceIdentifier> <ebcc:schemeUniformResourceIdentifier>NG </ebcc:postCodeIdentifier> <ebcc:countryCode> <ebcc:content>an..3</ebcc:content> <ebcc:listIdentifier>NG</ebcc:listIdentifier> <ebcc:listAgencyIdentifier>NG</ebcc:listAgencyIdentifier> <ebcc:listAgencyNameText>NG</ebcc:listAgencyNameText> <ebcc:listNameText>NG</ebcc:listNameText> <ebcc:listVersionIdentifier>NG</ebcc:listVersionIdentifier> <ebcc:nameText>NG</ebcc:nameText> <ebcc:languageIdentifier>NG</ebcc:languageIdentifier> <ebcc:listUniformResourceIdentifier>NG</ebcc:listUniformResourceIdentifier> <ebcc:listSchemeUniformResourceIdentifier>NG </ebcc:listSchemeUniformResourceIdentifier> </pre>

	<pre> </ebcc:countryCode> <ebcc:postOfficeBoxIdentifier>NG</ebcc:postOfficeBoxIdentifier> <ebcc:buildingIdentifier>NG</ebcc:buildingIdentifier> <ebcc:buildingName>NG</ebcc:buildingName> <ebcc:suiteIdentifier>NG</ebcc:suiteIdentifier> <ebcc:mailDeliverySubLocationIdentifier>NG</ebcc:mailDeliverySubLocationIdentifier> <ebcc:floorIdentifier>NG</ebcc:floorIdentifier> <ebcc:lotIdentifier>NG</ebcc:lotIdentifier> <ebcc:blockIdentifier>NG</ebcc:blockIdentifier> <ebcc:districtSubdivisionIdentifier>NG</ebcc:districtSubdivisionIdentifier> <ebcc:regionIdentifier>NG</ebcc:regionIdentifier> <ebcc:countyIdentifier>NG</ebcc:countyIdentifier> <ebcc:postalAddressFirstLineText> NG </ebcc:postalAddressFirstLineText> <ebcc:postalAddressSecondLineText>NG</ebcc:postalAddressSecondLineText> <ebcc:postalAddressThirdLineText>NG</ebcc:postalAddressThirdLineText> <ebcc:postalAddressFourthLineText>NG</ebcc:postalAddressFourthLineText> <ebcc:postalAddressFifthLineText>NG</ebcc:postalAddressFifthLineText> </dt:contactAddress> <dt:contactAddress> <ebcc:streetBuildingIdentifier> <ebcc:content>4</ebcc:content> </ebcc:streetBuildingIdentifier> <ebcc:streetName><ebcc:content>Hogeweg</ebcc:content></ebcc:streetName> <ebcc:townName><ebcc:content>Lisse</ebcc:content> </ebcc:townName> <ebcc:postCodeIdentifier> <ebcc:content>1234 AB</ebcc:content> </ebcc:postCodeIdentifier> <ebcc:countryCode><ebcc:content>NL</ebcc:content> </ebcc:countryCode> </dt:contactAddress> </pre>
communication-Details	<pre> Telefoon of faxnummer (optioneel). <dt:communicationDetails> <ebcc:typeCode>NG</ebcc:typeCode> <ebcc:modeCode> <ebcc:content>an..10</ebcc:content> <ebcc:listIdentifier>NG</ebcc:listIdentifier> <ebcc:listAgencyIdentifier>NG</ebcc:listAgencyIdentifier> <ebcc:listAgencyNameText>NG</ebcc:listAgencyNameText> <ebcc:listNameText>NG</ebcc:listNameText> <ebcc:listVersionIdentifier>NG</ebcc:listVersionIdentifier> <ebcc:nameText>NG</ebcc:nameText> <ebcc:languageIdentifier>NG</ebcc:languageIdentifier> <ebcc:listUniformResourceIdentifier>NG</ebcc:listUniformResourceIdentifier> <ebcc:listSchemeUniformResourceIdentifier>NG </ebcc:listSchemeUniformResourceIdentifier> </ebcc:modeCode> <ebcc:identifier> <ebcc:content>an..15</ebcc:content> <ebcc:schemeIdentifier>NG</ebcc:schemeIdentifier> <ebcc:schemeNameText>NG</ebcc:schemeNameText> <ebcc:schemeAgencyIdentifier>NG</ebcc:schemeAgencyIdentifier> <ebcc:schemeAgencyNameText>NG</ebcc:schemeAgencyNameText> <ebcc:schemeVersionIdentifier>NG</ebcc:schemeVersionIdentifier> <ebcc:schemeDataUniformResourceIdentifier>NG </ebcc:schemeDataUniformResourceIdentifier> <ebcc:schemeUniformResourceIdentifier>NG</ebcc:schemeUniformResourceIdentifier> </ebcc:identifier> <ebcc:telephoneCountryIdentifier>NG</ebcc:telephoneCountryIdentifier> <ebcc:telephoneAreaIdentifier>NG</ebcc:telephoneAreaIdentifier> <ebcc:telephoneSubscriberIdentifier>NG</ebcc:telephoneSubscriberIdentifier> <ebcc:telephoneExtensionIdentifier>NG</ebcc:telephoneExtensionIdentifier> </dt:communicationDetails> <dt:communicationDetails> <ebcc:modeCode> <ebcc:content>Tel</ebcc:content> </ebcc:modeCode> <ebcc:identifier> <ebcc:content>0105467182</ebcc:content> </ebcc:identifier> </dt:communicationDetails> </pre>

reference-Details	<p>Referentiegegevens. Referentie uitgegeven door de opdrachtgever (optioneel).</p> <pre> <dt:referenceDetails> <dt:referencelIdentifier> <ebcc:content>an..10</ebcc:content> <ebcc:schemelIdentifier>an..3</ebcc:schemelIdentifier> <ebcc:schemeNameText>NG</ebcc:schemeNameText> <ebcc:schemeAgencyIdentifier>n5</ebcc:schemeAgencyIdentifier> <ebcc:schemeAgencyNameText>NG</ebcc:schemeAgencyNameText> <ebcc:schemeVersionIdentifier>LON10</ebcc:schemeVersionIdentifier> <ebcc:schemeDataUniformResourceIdentifier>NG </ebcc:schemeDataUniformResourceIdentifier> <ebcc:schemeUniformResourceIdentifier>NG </ebcc:schemeUniformResourceIdentifier> </dt:referencelIdentifier> <dt:lineNumber> <ebcc:content>NG</ebcc:content> <ebcc:formatText>NG</ebcc:formatText> </dt:lineNumber> </dt:referenceDetails> </pre>
	<pre> <referenceDetails> <dt:referencelIdentifier> <ebcc:content>0003046564</ebcc:content> <ebcc:schemelIdentifier>FBB</ebcc:schemelIdentifier> <ebcc:schemeAgencyIdentifier>10253</ebcc:schemeAgencyIdentifier> <ebcc:schemeVersionIdentifier>LON10</ebcc:schemeVersionIdentifier> </dt:referencelIdentifier> </referenceDetails> </pre>

3.1.3.3 Element logistiekeOrder/consignee

Element t.b.v. het uniek identificeren van de geadresseerde (de ontvanger).

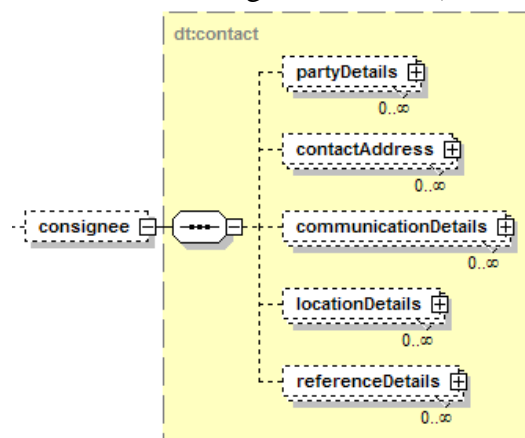

Element	Waarde
partyDetails (1)	<p>Unieke identificatie van de geadresseerde (ontvanger) middels edibulb NAW code en type CN.</p> <pre> <dt:partyDetails> <ebcc:identifier> <ebcc:content>n5</ebcc:content> <ebcc:schemeIdentifier>NG</ebcc:schemeIdentifier> <ebcc:schemeNameText>NG</ebcc:schemeNameText> <ebcc:schemeAgencyIdentifier>NG</ebcc:schemeAgencyIdentifier> <ebcc:schemeAgencyNameText>NG</ebcc:schemeAgencyNameText> <ebcc:schemeVersionIdentifier>NG</ebcc:schemeVersionIdentifier> <ebcc:schemeDataUniformResourceIdentifier>NG </ebcc:schemeDataUniformResourceIdentifier> <ebcc:schemeUniformResourceIdentifier>NG </ebcc:schemeUniformResourceIdentifier> </ebcc:identifier> <ebcc:descriptionText> <ebcc:content>NG</ebcc:content> <ebcc:languageIdentifier>NG</ebcc:languageIdentifier> <ebcc:languageLocaleIdentifier>NG</ebcc:languageLocaleIdentifier> </ebcc:descriptionText> <ebcc:typeCode> <ebcc:content>CN</ebcc:content> <ebcc:listIdentifier>NG</ebcc:listIdentifier> <ebcc:listAgencyIdentifier>NG</ebcc:listAgencyIdentifier> <ebcc:listAgencyNameText>NG</ebcc:listAgencyNameText> <ebcc:listNameText>NG</ebcc:listNameText> <ebcc:listVersionIdentifier>NG</ebcc:listVersionIdentifier> <ebcc:nameText>NG</ebcc:nameText> <ebcc:languageIdentifier>NG</ebcc:languageIdentifier> <ebcc:listUniformResourceIdentifier>NG</ebcc:listUniformResourceIdentifier> <ebcc:listSchemeUniformResourceIdentifier>NG </ebcc:listSchemeUniformResourceIdentifier> </ebcc:typeCode> <ebcc:personDetails> <ebcc:name> <ebcc:content>an..36</ebcc:content> <ebcc:languageIdentifier>NG</ebcc:languageIdentifier> <ebcc:languageLocaleIdentifier>NG</ebcc:languageLocaleIdentifier> </ebcc:name> <ebcc:taxIdentifier>NG</ebcc:taxIdentifier> <ebcc:birthDate>NG</ebcc:birthDate> </ebcc:personDetails> <ebcc:givenName> <ebcc:content>an..12</ebcc:content> <ebcc:languageIdentifier>NG</ebcc:languageIdentifier> <ebcc:languageLocaleIdentifier>NG</ebcc:languageLocaleIdentifier> </ebcc:givenName> <ebcc:middleName>NG</ebcc:middleName> <ebcc:surName> <ebcc:content>an.24</ebcc:content> <ebcc:languageIdentifier>NG</ebcc:languageIdentifier> <ebcc:languageLocaleIdentifier>NG</ebcc:languageLocaleIdentifier> </ebcc:surName> <ebcc:genderCode>NG</ebcc:genderCode> <ebcc:nationalityCode>NG</ebcc:nationalityCode> <ebcc:namePrefixCode>NG</ebcc:namePrefixCode> <ebcc:nameSuffixCode>NG</ebcc:nameSuffixCode> </ebcc:personDetails> <ebcc:organisationDetails>NG</ebcc:organisationDetails> </dt:partyDetails> <dt:partyDetails> <ebcc:identifier><ebcc:content>04762</ebcc:content></ebcc:identifier> <ebcc:typeCode><ebcc:content>CN</ebcc:content></ebcc:typeCode> </dt:partyDetails> </pre>
contactAddress	<p>Opgave van Straatnaam of 'Postbus', Vervolg straatnaam, huisnummer of postbusnummer, (woon)plaats, Postcode en Code van het land van vestiging (C, an..3). Zie EDIBULB codelijst Land, www.edibulb.nl.</p> <pre> <dt:contactAddress> <ebcc:typeCode>NG</ebcc:typeCode> <ebcc:streetBuildingIdentifier> </pre>

```

<ebcc:content>an..8</ebcc:content>
<ebcc:schemelIdentifier>NG</ebcc:schemelIdentifier>
<ebcc:schemeNameText>NG</ebcc:schemeNameText>
<ebcc:schemeAgencyIdentifier>NG</ebcc:schemeAgencyIdentifier>
<ebcc:schemeAgencyNameText>NG</ebcc:schemeAgencyNameText>
<ebcc:schemeVersionIdentifier>NG</ebcc:schemeVersionIdentifier>
<ebcc:schemeDataUniformResourceIdentifier>NG
</ebcc:schemeDataUniformResourceIdentifier>
<ebcc:schemeUniformResourceIdentifier>NG
</ebcc:schemeUniformResourceIdentifier>
</ebcc:streetBuildingIdentifier>
<ebcc:streetName>
<ebcc:content>an..43</ebcc:content>
<ebcc:languageIdentifier>NG</ebcc:languageIdentifier>
<ebcc:languageLocaleIdentifier>NG</ebcc:languageLocaleIdentifier>
</ebcc:streetName>
<ebcc:districtName> NG </ebcc:districtName>
<ebcc:townName>
<ebcc:content>an..24</ebcc:content>
<ebcc:languageIdentifier>NG</ebcc:languageIdentifier>
<ebcc:languageLocaleIdentifier>NG</ebcc:languageLocaleIdentifier>
</ebcc:townName>
<ebcc:stateIdentifier>NG</ebcc:stateIdentifier>
<ebcc:postCodeIdentifier>
<ebcc:content>an..9</ebcc:content>
<ebcc:schemelIdentifier>NG</ebcc:schemelIdentifier>
<ebcc:schemeNameText>NG</ebcc:schemeNameText>
<ebcc:schemeAgencyIdentifier>NG</ebcc:schemeAgencyIdentifier>
<ebcc:schemeAgencyNameText>NG</ebcc:schemeAgencyNameText>
<ebcc:schemeVersionIdentifier>NG</ebcc:schemeVersionIdentifier>
<ebcc:schemeDataUniformResourceIdentifier>NG
</ebcc:schemeDataUniformResourceIdentifier>
<ebcc:schemeUniformResourceIdentifier>NG
</ebcc:schemeUniformResourceIdentifier>
</ebcc:postCodeIdentifier>
<ebcc:countryCode>
<ebcc:content>an..3</ebcc:content>
<ebcc:listIdentifier>NG</ebcc:listIdentifier>
<ebcc:listAgencyIdentifier>NG</ebcc:listAgencyIdentifier>
<ebcc:listAgencyNameText>NG</ebcc:listAgencyNameText>
<ebcc:listNameText>NG</ebcc:listNameText>
<ebcc:listVersionIdentifier>NG</ebcc:listVersionIdentifier>
<ebcc:nameText>NG</ebcc:nameText>
<ebcc:languageIdentifier>NG</ebcc:languageIdentifier>
<ebcc:listUniformResourceIdentifier>NG</ebcc:listUniformResourceIdentifier>
<ebcc:listSchemeUniformResourceIdentifier>NG
</ebcc:listSchemeUniformResourceIdentifier>
</ebcc:countryCode>
<ebcc:postOfficeBoxIdentifier>NG</ebcc:postOfficeBoxIdentifier>
<ebcc:buildingIdentifier>NG</ebcc:buildingIdentifier>
<ebcc:buildingName>NG</ebcc:buildingName>
<ebcc:suiteIdentifier>NG</ebcc:suiteIdentifier>
<ebcc:mailDeliverySubLocationIdentifier>NG</ebcc:mailDeliverySubLocationIdentifier>
<ebcc:floorIdentifier>NG</ebcc:floorIdentifier>
<ebcc:lotIdentifier>NG</ebcc:lotIdentifier>
<ebcc:blockIdentifier>NG</ebcc:blockIdentifier>
<ebcc:districtSubdivisionIdentifier>NG</ebcc:districtSubdivisionIdentifier>
<ebcc:regionIdentifier>NG</ebcc:regionIdentifier>
<ebcc:countyIdentifier>NG</ebcc:countyIdentifier>
<ebcc:postalAddressFirstLineText> NG </ebcc:postalAddressFirstLineText>
<ebcc:postalAddressSecondLineText>NG</ebcc:postalAddressSecondLineText>
<ebcc:postalAddressThirdLineText>NG</ebcc:postalAddressThirdLineText>
<ebcc:postalAddressFourthLineText>NG</ebcc:postalAddressFourthLineText>
<ebcc:postalAddressFifthLineText>NG</ebcc:postalAddressFifthLineText>
</dt:contactAddress>

```

	<pre> <dt:contactAddress> <ebcc:streetBuildingIdentifier> <ebcc:content>6</ebcc:content> </ebcc:streetBuildingIdentifier> <ebcc:streetName><ebcc:content>Lageweg</ebcc:content></ebcc:streetName> <ebcc:townName><ebcc:content>Lisse</ebcc:content></ebcc:townName> <ebcc:postCodeIdentifier> <ebcc:content>4321 AB</ebcc:content> </ebcc:postCodeIdentifier> <ebcc:countryCode><ebcc:content>NL</ebcc:content></ebcc:countryCode> </dt:contactAddress> </pre>
Communicati- onDetails	<pre> Telefoon of faxnummer (optioneel). <dt:communicationDetails> <ebcc:typeCode>NG</ebcc:typeCode> <ebcc:modeCode> <ebcc:content>an..10</ebcc:content> <ebcc:listIdentifier>NG</ebcc:listIdentifier> <ebcc:listAgencyIdentifier>NG</ebcc:listAgencyIdentifier> <ebcc:listAgencyNameText>NG</ebcc:listAgencyNameText> <ebcc:listNameText>NG</ebcc:listNameText> <ebcc:listVersionIdentifier>NG</ebcc:listVersionIdentifier> <ebcc:nameText>NG</ebcc:nameText> <ebcc:languageIdentifier>NG</ebcc:languageIdentifier> <ebcc:listUniformResourceIdentifier>NG</ebcc:listUniformResourceIdentifier> <ebcc:listSchemeUniformResourceIdentifier>NG </ebcc:listSchemeUniformResourceIdentifier> </ebcc:modeCode> <ebcc:identifier> <ebcc:content>an..15</ebcc:content> <ebcc:schemeIdentifier>NG</ebcc:schemeIdentifier> <ebcc:schemeNameText>NG</ebcc:schemeNameText> <ebcc:schemeAgencyIdentifier>NG</ebcc:schemeAgencyIdentifier> <ebcc:schemeAgencyNameText>NG</ebcc:schemeAgencyNameText> <ebcc:schemeVersionIdentifier>NG</ebcc:schemeVersionIdentifier> <ebcc:schemeDataUniformResourceIdentifier>NG </ebcc:schemeDataUniformResourceIdentifier> <ebcc:schemeUniformResourceIdentifier>NG</ebcc:schemeUniformResourceIdentifier> </ebcc:identifier> <ebcc:telephoneCountryIdentifier>NG</ebcc:telephoneCountryIdentifier> <ebcc:telephoneAreaIdentifier>NG</ebcc:telephoneAreaIdentifier> <ebcc:telephoneSubscriberIdentifier>NG</ebcc:telephoneSubscriberIdentifier> <ebcc:telephoneExtensionIdentifier>NG</ebcc:telephoneExtensionIdentifier> </dt:communicationDetails> <dt:communicationDetails> <ebcc:modeCode> <ebcc:content>Tel</ebcc:content> </ebcc:modeCode> <ebcc:identifier> <ebcc:content>0205467182</ebcc:content> </ebcc:identifier> </dt:communicationDetails> </pre>
reference- Details	<pre> Referentiegegevens. Referentie uitgegeven door de ontvanger (optioneel). <dt:referenceDetails> <dt:referencelIdentifier> <ebcc:content>an..10</ebcc:content> <ebcc:schemeIdentifier>an..3</ebcc:schemeIdentifier> <ebcc:schemeNameText>NG</ebcc:schemeNameText> <ebcc:schemeAgencyIdentifier>n5</ebcc:schemeAgencyIdentifier> <ebcc:schemeAgencyNameText>NG</ebcc:schemeAgencyNameText> <ebcc:schemeVersionIdentifier>LON10</ebcc:schemeVersionIdentifier> <ebcc:schemeDataUniformResourceIdentifier>NG </ebcc:schemeDataUniformResourceIdentifier> <ebcc:schemeUniformResourceIdentifier>NG </ebcc:schemeUniformResourceIdentifier> </dt:referencelIdentifier> <dt:lineNumber> <ebcc:content>NG</ebcc:content> <ebcc:formatText>NG</ebcc:formatText> </dt:lineNumber> </pre>

<code></dt:referenceDetails></code>
<pre> <referenceDetails> <dt:referencelIdentifier> <ebcc:content>0003046564</ebcc:content> <ebcc:schemelIdentifier>FL</ebcc:schemelIdentifier> <ebcc:schemeAgencyIdentifier>10253</ebcc:schemeAgencyIdentifier> <ebcc:schemeVersionIdentifier>LON10</ebcc:schemeVersionIdentifier> </dt:referencelIdentifier> </referenceDetails> </pre>

3.1.3.4 Element logistiekeOrder/consignor

Element t.b.v. het uniek identificeren van de verzender.

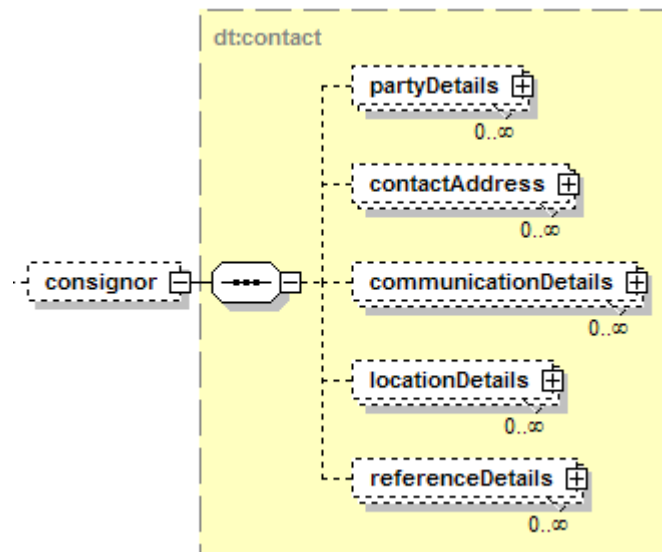

Element	Waarde
partyDetails (1)	<p>Unieke identificatie van de verzender middels edibulb NAW code en type CZ.</p> <pre> <dt:partyDetails> <ebcc:identifier> <ebcc:content>n5</ebcc:content> <ebcc:schemelIdentifier>NG</ebcc:schemelIdentifier> <ebcc:schemeNameText>NG</ebcc:schemeNameText> <ebcc:schemeAgencyIdentifier>NG</ebcc:schemeAgencyIdentifier> <ebcc:schemeAgencyNameText>NG</ebcc:schemeAgencyNameText> <ebcc:schemeVersionIdentifier>NG</ebcc:schemeVersionIdentifier> <ebcc:schemeDataUniformResourceIdentifier>NG </ebcc:schemeDataUniformResourceIdentifier> <ebcc:schemeUniformResourceIdentifier>NG </ebcc:schemeUniformResourceIdentifier> </ebcc:identifier> <ebcc:descriptionText> <ebcc:content>NG</ebcc:content> <ebcc:languageIdentifier>NG</ebcc:languageIdentifier> <ebcc:languageLocaleIdentifier>NG</ebcc:languageLocaleIdentifier> </ebcc:descriptionText> <ebcc:typeCode> <ebcc:content>IV</ebcc:content> <ebcc:listIdentifier>NG</ebcc:listIdentifier> <ebcc:listAgencyIdentifier>NG</ebcc:listAgencyIdentifier> <ebcc:listAgencyNameText>NG</ebcc:listAgencyNameText> <ebcc:listNameText>NG</ebcc:listNameText> <ebcc:listVersionIdentifier>NG</ebcc:listVersionIdentifier> <ebcc:nameText>NG</ebcc:nameText> <ebcc:languageIdentifier>NG</ebcc:languageIdentifier> <ebcc:listUniformResourceIdentifier>NG</ebcc:listUniformResourceIdentifier> <ebcc:listSchemeUniformResourceIdentifier>NG </pre>

	<pre> </ebcc:listSchemeUniformResourceIdentificer> </ebcc:typeCode> <ebcc:personDetails> <ebcc:name> <ebcc:content>an..36</ebcc:content> <ebcc:languageIdentifier>NG</ebcc:languageIdentifier> <ebcc:languageLocaleIdentifier>NG</ebcc:languageLocaleIdentifier> </ebcc:name> <ebcc:taxIdentifier>NG</ebcc:taxIdentifier> <ebcc:birthDate>NG</ebcc:birthDate> <ebcc:givenName> <ebcc:content>an..12</ebcc:content> <ebcc:languageIdentifier>NG</ebcc:languageIdentifier> <ebcc:languageLocaleIdentifier>NG</ebcc:languageLocaleIdentifier> </ebcc:givenName> <ebcc:middleName>NG</ebcc:middleName> <ebcc:surName> <ebcc:content>an.24</ebcc:content> <ebcc:languageIdentifier>NG</ebcc:languageIdentifier> <ebcc:languageLocaleIdentifier>NG</ebcc:languageLocaleIdentifier> </ebcc:surName> <ebcc:genderCode>NG</ebcc:genderCode> <ebcc:nationalityCode>NG</ebcc:nationalityCode> <ebcc:namePrefixCode>NG</ebcc:namePrefixCode> <ebcc:nameSuffixCode>NG</ebcc:nameSuffixCode> </ebcc:personDetails> <ebcc:organisationDetails>NG</ebcc:organisationDetails> </dt:partyDetails> <dt:partyDetails> <ebcc:identifier><ebcc:content>04762</ebcc:content></ebcc:identifier> <ebcc:typeCode><ebcc:content>CZ</ebcc:content></ebcc:typeCode> </dt:partyDetails> </pre>
contactAddress	<p>Opgave van Straatnaam of 'Postbus', Vervolg straatnaam, huisnummer of postbusnummer, (woon)plaats, Postcode en Code van het land van vestiging (C, an..3). Zie EDIBULB codelijst Land, www.edibulb.nl.</p> <pre> <dt:contactAddress> <ebcc:typeCode>NG</ebcc:typeCode> <ebcc:streetBuildingIdentifier> <ebcc:content>an..8</ebcc:content> <ebcc:schemeIdentifier>NG</ebcc:schemeIdentifier> <ebcc:schemeNameText>NG</ebcc:schemeNameText> <ebcc:schemeAgencyIdentifier>NG</ebcc:schemeAgencyIdentifier> <ebcc:schemeAgencyNameText>NG</ebcc:schemeAgencyNameText> <ebcc:schemeVersionIdentifier>NG</ebcc:schemeVersionIdentifier> <ebcc:schemeDataUniformResourceIdentifier>NG </ebcc:schemeDataUniformResourceIdentifier> <ebcc:schemeUniformResourceIdentifier>NG </ebcc:schemeUniformResourceIdentifier> </ebcc:streetBuildingIdentifier> <ebcc:streetName> <ebcc:content>an..43</ebcc:content> <ebcc:languageIdentifier>NG</ebcc:languageIdentifier> <ebcc:languageLocaleIdentifier>NG</ebcc:languageLocaleIdentifier> </ebcc:streetName> <ebcc:districtName> NG </ebcc:districtName> <ebcc:townName> <ebcc:content>an..24</ebcc:content> <ebcc:languageIdentifier>NG</ebcc:languageIdentifier> <ebcc:languageLocaleIdentifier>NG</ebcc:languageLocaleIdentifier> </ebcc:townName> <ebcc:stateIdentifier>NG</ebcc:stateIdentifier> <ebcc:postCodeIdentifier> <ebcc:content>an..9</ebcc:content> <ebcc:schemeIdentifier>NG</ebcc:schemeIdentifier> <ebcc:schemeNameText>NG</ebcc:schemeNameText> <ebcc:schemeAgencyIdentifier>NG</ebcc:schemeAgencyIdentifier> <ebcc:schemeAgencyNameText>NG</ebcc:schemeAgencyNameText> <ebcc:schemeVersionIdentifier>NG</ebcc:schemeVersionIdentifier> <ebcc:schemeDataUniformResourceIdentifier>NG </pre>

	<pre> </ebcc:schemeDataUniformResourceIdentifier> <ebcc:schemeUniformResourceIdentifier>NG </ebcc:schemeUniformResourceIdentifier> </ebcc:postCodeIdentifier> <ebcc:countryCode> <ebcc:content>an..3</ebcc:content> <ebcc:listIdentifier>NG</ebcc:listIdentifier> <ebcc:listAgencyIdentifier>NG</ebcc:listAgencyIdentifier> <ebcc:listAgencyNameText>NG</ebcc:listAgencyNameText> <ebcc:listNameText>NG</ebcc:listNameText> <ebcc:listVersionIdentifier>NG</ebcc:listVersionIdentifier> <ebcc:nameText>NG</ebcc:nameText> <ebcc:languageIdentifier>NG</ebcc:languageIdentifier> <ebcc:listUniformResourceIdentifier>NG</ebcc:listUniformResourceIdentifier> <ebcc:listSchemeUniformResourceIdentifier>NG </ebcc:listSchemeUniformResourceIdentifier> </ebcc:countryCode> <ebcc:postOfficeBoxIdentifier>NG</ebcc:postOfficeBoxIdentifier> <ebcc:buildingIdentifier>NG</ebcc:buildingIdentifier> <ebcc:buildingName>NG</ebcc:buildingName> <ebcc:suiteIdentifier>NG</ebcc:suiteIdentifier> <ebcc:mailDeliverySubLocationIdentifier>NG</ebcc:mailDeliverySubLocationIdentifier> <ebcc:floorIdentifier>NG</ebcc:floorIdentifier> <ebcc:lotIdentifier>NG</ebcc:lotIdentifier> <ebcc:blockIdentifier>NG</ebcc:blockIdentifier> <ebcc:districtSubdivisionIdentifier>NG</ebcc:districtSubdivisionIdentifier> <ebcc:regionIdentifier>NG</ebcc:regionIdentifier> <ebcc:countyIdentifier>NG</ebcc:countyIdentifier> <ebcc:postalAddressFirstLineText> NG </ebcc:postalAddressFirstLineText> <ebcc:postalAddressSecondLineText>NG</ebcc:postalAddressSecondLineText> <ebcc:postalAddressThirdLineText>NG</ebcc:postalAddressThirdLineText> <ebcc:postalAddressFourthLineText>NG</ebcc:postalAddressFourthLineText> <ebcc:postalAddressFifthLineText>NG</ebcc:postalAddressFifthLineText> </dt:contactAddress> <dt:contactAddress> <ebcc:streetBuildingIdentifier> <ebcc:content>4</ebcc:content> </ebcc:streetBuildingIdentifier> <ebcc:streetName><ebcc:content>Hogeweg</ebcc:content></ebcc:streetName> <ebcc:townName><ebcc:content>Lisse</ebcc:content></ebcc:townName> <ebcc:postCodeIdentifier> <ebcc:content>1234 AB</ebcc:content> </ebcc:postCodeIdentifier> <ebcc:countryCode><ebcc:content>NL</ebcc:content></ebcc:countryCode> </dt:contactAddress> </pre>
communication-Details	<pre> Telefoon of faxnummer (optioneel). <dt:communicationDetails> <ebcc:typeCode>NG</ebcc:typeCode> <ebcc:modeCode> <ebcc:content>an..10</ebcc:content> <ebcc:listIdentifier>NG</ebcc:listIdentifier> <ebcc:listAgencyIdentifier>NG</ebcc:listAgencyIdentifier> <ebcc:listAgencyNameText>NG</ebcc:listAgencyNameText> <ebcc:listNameText>NG</ebcc:listNameText> <ebcc:listVersionIdentifier>NG</ebcc:listVersionIdentifier> <ebcc:nameText>NG</ebcc:nameText> <ebcc:languageIdentifier>NG</ebcc:languageIdentifier> <ebcc:listUniformResourceIdentifier>NG</ebcc:listUniformResourceIdentifier> <ebcc:listSchemeUniformResourceIdentifier>NG </ebcc:listSchemeUniformResourceIdentifier> </ebcc:modeCode> <ebcc:identifier> <ebcc:content>an..15</ebcc:content> <ebcc:schemeIdentifier>NG</ebcc:schemeIdentifier> <ebcc:schemeNameText>NG</ebcc:schemeNameText> <ebcc:schemeAgencyIdentifier>NG</ebcc:schemeAgencyIdentifier> <ebcc:schemeAgencyNameText>NG</ebcc:schemeAgencyNameText> <ebcc:schemeVersionIdentifier>NG</ebcc:schemeVersionIdentifier> <ebcc:schemeDataUniformResourceIdentifier>NG </pre>

	<pre> </ebcc:schemeDataUniformResourceIdentifier> <ebcc:schemeUniformResourceIdentifier>NG</ebcc:schemeUniformResourceIdentifier> </ebcc:identifier> <ebcc:telephoneCountryIdentifier>NG</ebcc:telephoneCountryIdentifier> <ebcc:telephoneAreaIdentifier>NG</ebcc:telephoneAreaIdentifier> <ebcc:telephoneSubscriberIdentifier>NG</ebcc:telephoneSubscriberIdentifier> <ebcc:telephoneExtensionIdentifier>NG</ebcc:telephoneExtensionIdentifier> </dt:communicationDetails> <dt:communicationDetails> <ebcc:modeCode> <ebcc:content>Tel</ebcc:content> </ebcc:modeCode> <ebcc:identifier> <ebcc:content>0305467182</ebcc:content> </ebcc:identifier> </dt:communicationDetails> </pre>
reference-Details	<pre> Referentiegegevens. Referentie uitgegeven door de verzender (optioneel). <dt:referenceDetails> <dt:referenceIdentifier> <ebcc:content>an..10</ebcc:content> <ebcc:schemeIdentifier>an..3</ebcc:schemeIdentifier> <ebcc:schemeNameText>NG</ebcc:schemeNameText> <ebcc:schemeAgencyIdentifier>n5</ebcc:schemeAgencyIdentifier> <ebcc:schemeAgencyNameText>NG</ebcc:schemeAgencyNameText> <ebcc:schemeVersionIdentifier>LON10</ebcc:schemeVersionIdentifier> <ebcc:schemeDataUniformResourceIdentifier>NG </ebcc:schemeDataUniformResourceIdentifier> <ebcc:schemeUniformResourceIdentifier>NG </ebcc:schemeUniformResourceIdentifier> </dt:referenceIdentifier> <dt:lineNumber> <ebcc:content>NG</ebcc:content> <ebcc:formatText>NG</ebcc:formatText> </dt:lineNumber> </dt:referenceDetails> <referenceDetails> <dt:referenceIdentifier> <ebcc:content>0003046564</ebcc:content> <ebcc:schemeIdentifier>FTO</ebcc:schemeIdentifier> <ebcc:schemeAgencyIdentifier>10253</ebcc:schemeAgencyIdentifier> <ebcc:schemeVersionIdentifier>LON10</ebcc:schemeVersionIdentifier> </dt:referenceIdentifier> </referenceDetails> </pre>

3.1.3.5 Element logistiekeOrder/carrier

Element t.b.v. het uniek identificeren van de vervoerder.

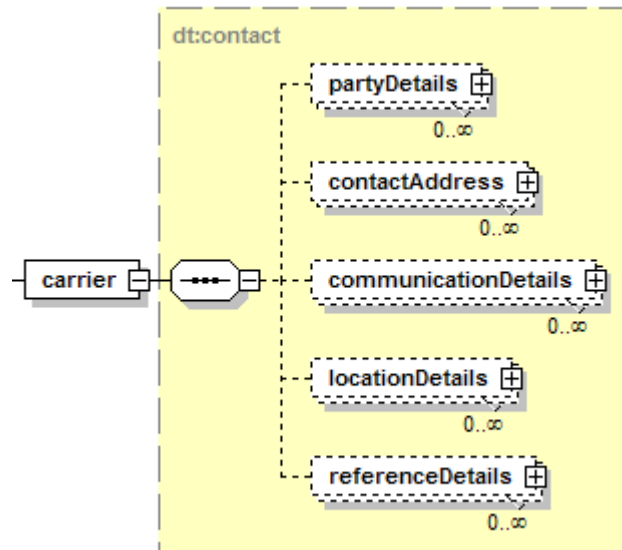

Element	Waarde
partyDetails (1)	<p>Unieke identificatie van de vervoerder middels Edibulb NAW code en type CA. Tevens identificatie contactpersoon.</p> <pre> <dt:partyDetails> <ebcc:identifier> <ebcc:content>n5</ebcc:content> <ebcc:schemelIdentifier>NG</ebcc:schemelIdentifier> <ebcc:schemeNameText>NG</ebcc:schemeNameText> <ebcc:schemeAgencyIdentifier>NG</ebcc:schemeAgencyIdentifier> <ebcc:schemeAgencyNameText>NG</ebcc:schemeAgencyNameText> <ebcc:schemeVersionIdentifier>NG</ebcc:schemeVersionIdentifier> <ebcc:schemeDataUniformResourceIdentifier>NG </ebcc:schemeDataUniformResourceIdentifier> <ebcc:schemeUniformResourceIdentifier>NG </ebcc:schemeUniformResourceIdentifier> </ebcc:identifier> <ebcc:descriptionText> <ebcc:content>NG</ebcc:content> <ebcc:languageIdentifier>NG</ebcc:languageIdentifier> <ebcc:languageLocaleIdentifier>NG</ebcc:languageLocaleIdentifier> </ebcc:descriptionText> <ebcc:typeCode> <ebcc:content>CA</ebcc:content> <ebcc:listIdentifier>NG</ebcc:listIdentifier> <ebcc:listAgencyIdentifier>NG</ebcc:listAgencyIdentifier> <ebcc:listAgencyNameText>NG</ebcc:listAgencyNameText> <ebcc:listNameText>NG</ebcc:listNameText> <ebcc:listVersionIdentifier>NG</ebcc:listVersionIdentifier> <ebcc:nameText>NG</ebcc:nameText> <ebcc:languageIdentifier>NG</ebcc:languageIdentifier> <ebcc:listUniformResourceIdentifier>NG</ebcc:listUniformResourceIdentifier> <ebcc:listSchemeUniformResourceIdentifier>NG </ebcc:listSchemeUniformResourceIdentifier> </ebcc:typeCode> <ebcc:personDetails> <ebcc:name> <ebcc:content>an..36</ebcc:content> <ebcc:languageIdentifier>NG</ebcc:languageIdentifier> <ebcc:languageLocaleIdentifier>NG</ebcc:languageLocaleIdentifier> </ebcc:name> </pre>

	<pre> <ebcc:taxIdentifier>NG</ebcc:taxIdentifier> <ebcc:birthDate>NG</ebcc:birthDate> <ebcc:givenName> <ebcc:content>an..12</ebcc:content> <ebcc:languageIdentifier>NG</ebcc:languageIdentifier> <ebcc:languageLocaleIdentifier>NG</ebcc:languageLocaleIdentifier> </ebcc:givenName> <ebcc:middleName>NG</ebcc:middleName> <ebcc:surName> <ebcc:content>an..24</ebcc:content> <ebcc:languageIdentifier>NG</ebcc:languageIdentifier> <ebcc:languageLocaleIdentifier>NG</ebcc:languageLocaleIdentifier> </ebcc:surName> <ebcc:genderCode>NG</ebcc:genderCode> <ebcc:nationalityCode>NG</ebcc:nationalityCode> <ebcc:namePrefixCode>NG</ebcc:namePrefixCode> <ebcc:nameSuffixCode>NG</ebcc:nameSuffixCode> </ebcc:personDetails> <ebcc:organisationDetails>NG</ebcc:organisationDetails> </dt:partyDetails> </pre>
	<pre> < dt:partyDetails> <ebcc:identifier><ebcc:content>09370</ebcc:content></ebcc:identifier> <ebcc:typeCode><ebcc:content>CA</ebcc:content></ebcc:typeCode> </ dt:partyDetails> </pre>
contactAddress	<p>Opgave van Straatnaam of 'Postbus', Vervolg straatnaam, huisnummer of postbusnummer, (woon)plaats, Postcode en Code van het land van vestiging (C, an..3). Zie EDIBULB codelijst Land, www.edibulb.nl.</p> <pre> <dt:contactAddress> <ebcc:typeCode>NG</ebcc:typeCode> <ebcc:streetBuildingIdentifier> <ebcc:content>an..8</ebcc:content> <ebcc:schemelIdentifier>NG</ebcc:schemelIdentifier> <ebcc:schemeNameText>NG</ebcc:schemeNameText> <ebcc:schemeAgencyIdentifier>NG</ebcc:schemeAgencyIdentifier> <ebcc:schemeAgencyNameText>NG</ebcc:schemeAgencyNameText> <ebcc:schemeVersionIdentifier>NG</ebcc:schemeVersionIdentifier> <ebcc:schemeDataUniformResourceIdentifier>NG </ebcc:schemeDataUniformResourceIdentifier> <ebcc:schemeUniformResourceIdentifier>NG</ebcc:schemeUniformResourceIdentifier> </ebcc:streetBuildingIdentifier> <ebcc:streetName> <ebcc:content>an..43</ebcc:content> <ebcc:languageIdentifier>NG</ebcc:languageIdentifier> <ebcc:languageLocaleIdentifier>NG</ebcc:languageLocaleIdentifier> </ebcc:streetName> <ebcc:districtName> NG </ebcc:districtName> <ebcc:townName> <ebcc:content>an..24</ebcc:content> <ebcc:languageIdentifier>NG</ebcc:languageIdentifier> <ebcc:languageLocaleIdentifier>NG</ebcc:languageLocaleIdentifier> </ebcc:townName> <ebcc:stateIdentifier>NG</ebcc:stateIdentifier> <ebcc:postCodeIdentifier> <ebcc:content>an..9</ebcc:content> <ebcc:schemelIdentifier>NG</ebcc:schemelIdentifier> <ebcc:schemeNameText>NG</ebcc:schemeNameText> <ebcc:schemeAgencyIdentifier>NG</ebcc:schemeAgencyIdentifier> <ebcc:schemeAgencyNameText>NG</ebcc:schemeAgencyNameText> <ebcc:schemeVersionIdentifier>NG</ebcc:schemeVersionIdentifier> <ebcc:schemeDataUniformResourceIdentifier>NG </ebcc:schemeDataUniformResourceIdentifier> <ebcc:schemeUniformResourceIdentifier>NG </ebcc:schemeUniformResourceIdentifier> </ebcc:postCodeIdentifier> <ebcc:countryCode> <ebcc:content>an..3</ebcc:content> <ebcc:listIdentifier>NG</ebcc:listIdentifier> <ebcc:listAgencyIdentifier>NG</ebcc:listAgencyIdentifier> <ebcc:listAgencyNameText>NG</ebcc:listAgencyNameText> </pre>

	<pre> <ebcc:listNameText>NG</ebcc:listNameText> <ebcc:listVersionIdentifier>NG</ebcc:listVersionIdentifier> <ebcc:nameText>NG</ebcc:nameText> <ebcc:languageIdentifier>NG</ebcc:languageIdentifier> <ebcc:listUniformResourceIdentifier>NG</ebcc:listUniformResourceIdentifier> <ebcc:listSchemeUniformResourceIdentifier>NG </ebcc:listSchemeUniformResourceIdentifier> </ebcc:countryCode> <ebcc:postOfficeBoxIdentifier>NG</ebcc:postOfficeBoxIdentifier> <ebcc:buildingIdentifier>NG</ebcc:buildingIdentifier> <ebcc:buildingName>NG</ebcc:buildingName> <ebcc:suiteIdentifier>NG</ebcc:suiteIdentifier> <ebcc:mailDeliverySubLocationIdentifier>NG</ebcc:mailDeliverySubLocationIdentifier> <ebcc:floorIdentifier>NG</ebcc:floorIdentifier> <ebcc:lotIdentifier>NG</ebcc:lotIdentifier> <ebcc:blockIdentifier>NG</ebcc:blockIdentifier> <ebcc:districtSubdivisionIdentifier>NG</ebcc:districtSubdivisionIdentifier> <ebcc:regionIdentifier>NG</ebcc:regionIdentifier> <ebcc:countyIdentifier>NG</ebcc:countyIdentifier> <ebcc:postalAddressFirstLineText> NG </ebcc:postalAddressFirstLineText> <ebcc:postalAddressSecondLineText>NG</ebcc:postalAddressSecondLineText> <ebcc:postalAddressThirdLineText>NG</ebcc:postalAddressThirdLineText> <ebcc:postalAddressFourthLineText>NG</ebcc:postalAddressFourthLineText> <ebcc:postalAddressFifthLineText>NG</ebcc:postalAddressFifthLineText> </dt:contactAddress> <dt:contactAddress> <ebcc:streetBuildingIdentifier> <ebcc:content>1</ebcc:content> </ebcc:streetBuildingIdentifier> <ebcc:streetName><ebcc:content>Tussenweg</ebcc:content></ebcc:streetName> <ebcc:townName><ebcc:content>Lisse</ebcc:content></ebcc:townName> <ebcc:postCodeIdentifier> <ebcc:content>6578 AB</ebcc:content> </ebcc:postCodeIdentifier> <ebcc:countryCode><ebcc:content>NL</ebcc:content> </ebcc:countryCode> </dt:contactAddress> </pre>
communication-Details	<pre> Telefoon of faxnummer (optioneel). <dt:communicationDetails> <ebcc:typeCode>NG</ebcc:typeCode> <ebcc:modeCode> <ebcc:content>an..10</ebcc:content> <ebcc:listIdentifier>NG</ebcc:listIdentifier> <ebcc:listAgencyIdentifier>NG</ebcc:listAgencyIdentifier> <ebcc:listAgencyNameText>NG</ebcc:listAgencyNameText> <ebcc:listNameText>NG</ebcc:listNameText> <ebcc:listVersionIdentifier>NG</ebcc:listVersionIdentifier> <ebcc:nameText>NG</ebcc:nameText> <ebcc:languageIdentifier>NG</ebcc:languageIdentifier> <ebcc:listUniformResourceIdentifier>NG</ebcc:listUniformResourceIdentifier> <ebcc:listSchemeUniformResourceIdentifier>NG </ebcc:listSchemeUniformResourceIdentifier> </ebcc:modeCode> <ebcc:identifier> <ebcc:content>an..15</ebcc:content> <ebcc:schemeIdentifier>NG</ebcc:schemeIdentifier> <ebcc:schemeNameText>NG</ebcc:schemeNameText> <ebcc:schemeAgencyIdentifier>NG</ebcc:schemeAgencyIdentifier> <ebcc:schemeAgencyNameText>NG</ebcc:schemeAgencyNameText> <ebcc:schemeVersionIdentifier>NG</ebcc:schemeVersionIdentifier> <ebcc:schemeDataUniformResourceIdentifier>NG </ebcc:schemeDataUniformResourceIdentifier> <ebcc:schemeUniformResourceIdentifier>NG</ebcc:schemeUniformResourceIdentifier> </ebcc:identifier> <ebcc:telephoneCountryIdentifier>NG</ebcc:telephoneCountryIdentifier> <ebcc:telephoneAreaIdentifier>NG</ebcc:telephoneAreaIdentifier> <ebcc:telephoneSubscriberIdentifier>NG</ebcc:telephoneSubscriberIdentifier> <ebcc:telephoneExtensionIdentifier>NG</ebcc:telephoneExtensionIdentifier> </dt:communicationDetails> </pre>

	<pre> <dt:communicationDetails> <ebcc:modeCode> <ebcc:content>Tel</ebcc:content> </ebcc:modeCode> <ebcc:identifier> <ebcc:content>0405467182</ebcc:content> </ebcc:identifier> </dt:communicationDetails> </pre>
reference-Details	<p>Referentiegegevens. Referentie uitgegeven door de vervoerder (optioneel).</p> <pre> <dt:referenceDetails> <dt:referencelIdentifier> <ebcc:content>an..10</ebcc:content> <ebcc:schemelIdentifier>an..3</ebcc:schemelIdentifier> <ebcc:schemeNameText>NG</ebcc:schemeNameText> <ebcc:schemeAgencyIdentifier>n5</ebcc:schemeAgencyIdentifier> <ebcc:schemeAgencyNameText>NG</ebcc:schemeAgencyNameText> <ebcc:schemeVersionIdentifier>LON10</ebcc:schemeVersionIdentifier> <ebcc:schemeDataUniformResourceIdentifier>NG </ebcc:schemeDataUniformResourceIdentifier> <ebcc:schemeUniformResourceIdentifier>NG </ebcc:schemeUniformResourceIdentifier> </dt:referencelIdentifier> <dt:lineNumber> <ebcc:content>NG</ebcc:content> <ebcc:formatText>NG</ebcc:formatText> </dt:lineNumber> </dt:referenceDetails> </pre> <pre> <referenceDetails> <dt:referencelIdentifier> <ebcc:content>0003046564</ebcc:content> <ebcc:schemelIdentifier>FTO</ebcc:schemelIdentifier> <ebcc:schemeAgencyIdentifier>10253</ebcc:schemeAgencyIdentifier> <ebcc:schemeVersionIdentifier>LON10</ebcc:schemeVersionIdentifier> </dt:referencelIdentifier> </referenceDetails> </pre>

3.1.3.6 Element logistiekeOrder/freightPayer

Element t.b.v. het uniek identificeren van de betaler van het transport.

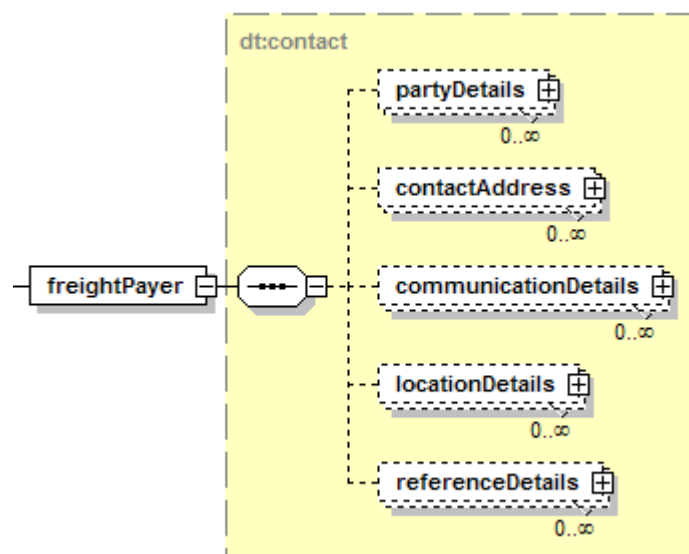

Element	Waarde
partyDetails (1)	<p>Unieke identificatie van de betaler van het transport middels Edibulb NAW code en type FP. Tevens identificatie contactpersoon.</p> <pre> <dt:partyDetails> <ebcc:identifier> <ebcc:content>n5</ebcc:content> <ebcc:schemeIdentifier>NG</ebcc:schemeIdentifier> <ebcc:schemeNameText>NG</ebcc:schemeNameText> <ebcc:schemeAgencyIdentifier>NG</ebcc:schemeAgencyIdentifier> <ebcc:schemeAgencyNameText>NG</ebcc:schemeAgencyNameText> <ebcc:schemeVersionIdentifier>NG</ebcc:schemeVersionIdentifier> <ebcc:schemeDataUniformResourceIdentifier>NG </ebcc:schemeDataUniformResourceIdentifier> <ebcc:schemeUniformResourceIdentifier>NG </ebcc:schemeUniformResourceIdentifier> </ebcc:identifier> <ebcc:descriptionText> <ebcc:content>NG</ebcc:content> <ebcc:languageIdentifier>NG</ebcc:languageIdentifier> <ebcc:languageLocaleIdentifier>NG</ebcc:languageLocaleIdentifier> </ebcc:descriptionText> <ebcc:typeCode> <ebcc:content>FP</ebcc:content> <ebcc:listIdentifier>NG</ebcc:listIdentifier> <ebcc:listAgencyIdentifier>NG</ebcc:listAgencyIdentifier> <ebcc:listAgencyNameText>NG</ebcc:listAgencyNameText> <ebcc:listNameText>NG</ebcc:listNameText> <ebcc:listVersionIdentifier>NG</ebcc:listVersionIdentifier> <ebcc:nameText>NG</ebcc:nameText> <ebcc:languageIdentifier>NG</ebcc:languageIdentifier> <ebcc:listUniformResourceIdentifier>NG</ebcc:listUniformResourceIdentifier> <ebcc:listSchemeUniformResourceIdentifier>NG </ebcc:listSchemeUniformResourceIdentifier> </ebcc:typeCode> <ebcc:personDetails> <ebcc:name> <ebcc:content>an..36</ebcc:content> <ebcc:languageIdentifier>NG</ebcc:languageIdentifier> <ebcc:languageLocaleIdentifier>NG</ebcc:languageLocaleIdentifier> </ebcc:name> <ebcc:taxIdentifier>NG</ebcc:taxIdentifier> <ebcc:birthDate>NG</ebcc:birthDate> <ebcc:givenName> <ebcc:content>an..12</ebcc:content> <ebcc:languageIdentifier>NG</ebcc:languageIdentifier> <ebcc:languageLocaleIdentifier>NG</ebcc:languageLocaleIdentifier> </ebcc:givenName> <ebcc:middleName>NG</ebcc:middleName> <ebcc:surName> <ebcc:content>an..24</ebcc:content> <ebcc:languageIdentifier>NG</ebcc:languageIdentifier> <ebcc:languageLocaleIdentifier>NG</ebcc:languageLocaleIdentifier> </ebcc:surName> <ebcc:genderCode>NG</ebcc:genderCode> <ebcc:nationalityCode>NG</ebcc:nationalityCode> <ebcc:namePrefixCode>NG</ebcc:namePrefixCode> <ebcc:nameSuffixCode>NG</ebcc:nameSuffixCode> </ebcc:personDetails> <ebcc:organisationDetails>NG</ebcc:organisationDetails> </dt:partyDetails> < dt:partyDetails> <ebcc:identifier><ebcc:content>09370</ebcc:content></ebcc:identifier> <ebcc:typeCode><ebcc:content>FP</ebcc:content></ebcc:typeCode> </ dt:partyDetails> </pre>
contactAddress	<p>Opgave van Straatnaam of 'Postbus', Vervolg straatnaam, huisnummer of postbusnummer, (woon)plaats, Postcode en Code van het land van vestiging (C, an..3). Zie EDIBULB codelijst Land, www.edibulb.nl.</p> <pre> <dt:contactAddress> <ebcc:typeCode>NG</ebcc:typeCode> </pre>

<pre> <ebcc:streetBuildingIdentifier> <ebcc:content>an..8</ebcc:content> <ebcc:schemelIdentifier>NG</ebcc:schemelIdentifier> <ebcc:schemeNameText>NG</ebcc:schemeNameText> <ebcc:schemeAgencyIdentifier>NG</ebcc:schemeAgencyIdentifier> <ebcc:schemeAgencyNameText>NG</ebcc:schemeAgencyNameText> <ebcc:schemeVersionIdentifier>NG</ebcc:schemeVersionIdentifier> <ebcc:schemeDataUniformResourceIdentifier>NG </ebcc:schemeDataUniformResourceIdentifier> <ebcc:schemeUniformResourceIdentifier>NG</ebcc:schemeUniformResourceIdentifier> </ebcc:streetBuildingIdentifier> <ebcc:streetName> <ebcc:content>an..43</ebcc:content> <ebcc:languageIdentifier>NG</ebcc:languageIdentifier> <ebcc:languageLocaleIdentifier>NG</ebcc:languageLocaleIdentifier> </ebcc:streetName> <ebcc:districtName> NG </ebcc:districtName> <ebcc:townName> <ebcc:content>an..24</ebcc:content> <ebcc:languageIdentifier>NG</ebcc:languageIdentifier> <ebcc:languageLocaleIdentifier>NG</ebcc:languageLocaleIdentifier> </ebcc:townName> <ebcc:stateIdentifier>NG</ebcc:stateIdentifier> <ebcc:postCodeIdentifier> <ebcc:content>an..9</ebcc:content> <ebcc:schemelIdentifier>NG</ebcc:schemelIdentifier> <ebcc:schemeNameText>NG</ebcc:schemeNameText> <ebcc:schemeAgencyIdentifier>NG</ebcc:schemeAgencyIdentifier> <ebcc:schemeAgencyNameText>NG</ebcc:schemeAgencyNameText> <ebcc:schemeVersionIdentifier>NG</ebcc:schemeVersionIdentifier> <ebcc:schemeDataUniformResourceIdentifier>NG </ebcc:schemeDataUniformResourceIdentifier> <ebcc:schemeUniformResourceIdentifier>NG </ebcc:schemeUniformResourceIdentifier> </ebcc:postCodeIdentifier> <ebcc:countryCode> <ebcc:content>an..3</ebcc:content> <ebcc:listIdentifier>NG</ebcc:listIdentifier> <ebcc:listAgencyIdentifier>NG</ebcc:listAgencyIdentifier> <ebcc:listAgencyNameText>NG</ebcc:listAgencyNameText> <ebcc:listNameText>NG</ebcc:listNameText> <ebcc:listVersionIdentifier>NG</ebcc:listVersionIdentifier> <ebcc:nameText>NG</ebcc:nameText> <ebcc:languageIdentifier>NG</ebcc:languageIdentifier> <ebcc:listUniformResourceIdentifier>NG</ebcc:listUniformResourceIdentifier> <ebcc:listSchemeUniformResourceIdentifier>NG </ebcc:listSchemeUniformResourceIdentifier> </ebcc:countryCode> <ebcc:postOfficeBoxIdentifier>NG</ebcc:postOfficeBoxIdentifier> <ebcc:buildingIdentifier>NG</ebcc:buildingIdentifier> <ebcc:buildingName>NG</ebcc:buildingName> <ebcc:suiteIdentifier>NG</ebcc:suiteIdentifier> <ebcc:mailDeliverySubLocationIdentifier>NG</ebcc:mailDeliverySubLocationIdentifier> <ebcc:floorIdentifier>NG</ebcc:floorIdentifier> <ebcc:lotIdentifier>NG</ebcc:lotIdentifier> <ebcc:blockIdentifier>NG</ebcc:blockIdentifier> <ebcc:districtSubdivisionIdentifier>NG</ebcc:districtSubdivisionIdentifier> <ebcc:regionIdentifier>NG</ebcc:regionIdentifier> <ebcc:countyIdentifier>NG</ebcc:countyIdentifier> <ebcc:postalAddressFirstLineText> NG </ebcc:postalAddressFirstLineText> <ebcc:postalAddressSecondLineText>NG</ebcc:postalAddressSecondLineText> <ebcc:postalAddressThirdLineText>NG</ebcc:postalAddressThirdLineText> <ebcc:postalAddressFourthLineText>NG</ebcc:postalAddressFourthLineText> <ebcc:postalAddressFifthLineText>NG</ebcc:postalAddressFifthLineText> </dt:contactAddress> <dt:contactAddress> <ebcc:streetBuildingIdentifier> <ebcc:content>100</ebcc:content> </ebcc:streetBuildingIdentifier> </pre>

	<pre><ebcc:streetName><ebcc:content>Voorweg</ebcc:content></ebcc:streetName> <ebcc:townName><ebcc:content>Lisse</ebcc:content></ebcc:townName> <ebcc:postCodeIdentifier> <ebcc:content>7865 AB</ebcc:content> </ebcc:postCodeIdentifier> <ebcc:countryCode><ebcc:content>NL</ebcc:content> </ebcc:countryCode> </dt:contactAddress></pre>
communication-Details	<p>Telefoon of faxnummer (optioneel).</p> <pre><dt:communicationDetails> <ebcc:typeCode>NG</ebcc:typeCode> <ebcc:modeCode> <ebcc:content>an..10</ebcc:content> <ebcc:listIdentifier>NG</ebcc:listIdentifier> <ebcc:listAgencyIdentifier>NG</ebcc:listAgencyIdentifier> <ebcc:listAgencyNameText>NG</ebcc:listAgencyNameText> <ebcc:listNameText>NG</ebcc:listNameText> <ebcc:listVersionIdentifier>NG</ebcc:listVersionIdentifier> <ebcc:nameText>NG</ebcc:nameText> <ebcc:languageIdentifier>NG</ebcc:languageIdentifier> <ebcc:listUniformResourceIdentifier>NG</ebcc:listUniformResourceIdentifier> <ebcc:listSchemeUniformResourceIdentifier>NG </ebcc:listSchemeUniformResourceIdentifier> </ebcc:modeCode> <ebcc:identifier> <ebcc:content>an..15</ebcc:content> <ebcc:schemeIdentifier>NG</ebcc:schemeIdentifier> <ebcc:schemeNameText>NG</ebcc:schemeNameText> <ebcc:schemeAgencyIdentifier>NG</ebcc:schemeAgencyIdentifier> <ebcc:schemeAgencyNameText>NG</ebcc:schemeAgencyNameText> <ebcc:schemeVersionIdentifier>NG</ebcc:schemeVersionIdentifier> <ebcc:schemeDataUniformResourceIdentifier>NG </ebcc:schemeDataUniformResourceIdentifier> <ebcc:schemeUniformResourceIdentifier>NG</ebcc:schemeUniformResourceIdentifier> </ebcc:identifier> <ebcc:telephoneCountryIdentifier>NG</ebcc:telephoneCountryIdentifier> <ebcc:telephoneAreaIdentifier>NG</ebcc:telephoneAreaIdentifier> <ebcc:telephoneSubscriberIdentifier>NG</ebcc:telephoneSubscriberIdentifier> <ebcc:telephoneExtensionIdentifier>NG</ebcc:telephoneExtensionIdentifier> </dt:communicationDetails> <dt:communicationDetails> <ebcc:modeCode> <ebcc:content>Tel</ebcc:content> </ebcc:modeCode> <ebcc:identifier> <ebcc:content>0405467182</ebcc:content> </ebcc:identifier> </dt:communicationDetails></pre>
reference-Details	<p>Referentiegegevens. Referentie uitgegeven door de betaler van het transport (optioneel).</p> <pre><dt:referenceDetails> <dt:referencelIdentifier> <ebcc:content>an..10</ebcc:content> <ebcc:schemeIdentifier>an..3</ebcc:schemeIdentifier> <ebcc:schemeNameText>NG</ebcc:schemeNameText> <ebcc:schemeAgencyIdentifier>n5</ebcc:schemeAgencyIdentifier> <ebcc:schemeAgencyNameText>NG</ebcc:schemeAgencyNameText> <ebcc:schemeVersionIdentifier>LON10</ebcc:schemeVersionIdentifier> <ebcc:schemeDataUniformResourceIdentifier>NG </ebcc:schemeDataUniformResourceIdentifier> <ebcc:schemeUniformResourceIdentifier>NG </ebcc:schemeUniformResourceIdentifier> </dt:referencelIdentifier> <dt:lineNumber> <ebcc:content>NG</ebcc:content> <ebcc:formatText>NG</ebcc:formatText> </dt:lineNumber> </dt:referenceDetails> <referenceDetails> <dt:referencelIdentifier> <ebcc:content>0003046564</ebcc:content></pre>

	<pre> <ebcc:schemelidener>FTO</ebcc:schemelidener> <ebcc:schemeAgencyIdentifier>10253</ebcc:schemeAgencyIdentifier> <ebcc:schemeVersionIdentifier>LON10</ebcc:schemeVersionIdentifier> </dt:referencelidener> </referencelidener> </pre>
--	--

3.1.3.7 Element logistiekeOrder/freetext

Element waarin vrije tekst kan worden geplaatst.

freetext (0..5)	Vrije tekst voor condities die niet gecodeerd kunnen worden of zijn (optioneel).
	<pre> <freetext> <ebcc:content>an..80</ebcc:content> <ebcc:languageIdentifier>NG</ebcc:languageIdentifier> <ebcc:languageLocaleIdentifier>NG</ebcc:languageLocaleIdentifier> </freetext> <freetext><ebcc:content>Opmerking 1</ebcc:content></freetext> <freetext><ebcc:content>Opmerking 2</ebcc:content></freetext> </pre>

3.1.3.8 Element logistiekeOrder/lineltemDetails

Element welke een volledige logistiekeorderregel bevat.

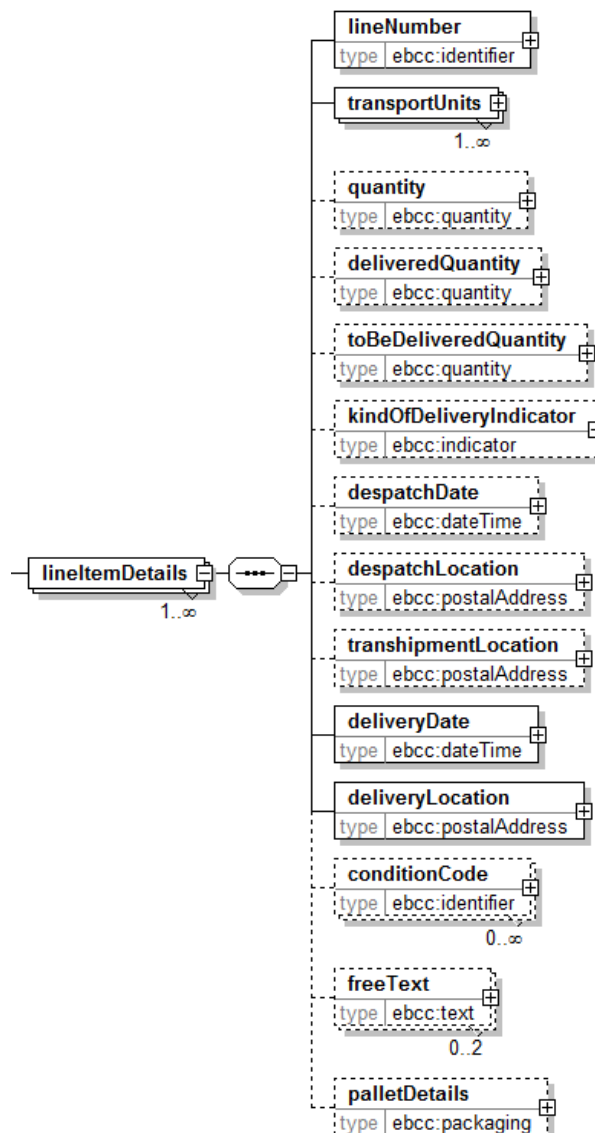

Element	Waarde
lineNumber	<p>Logistieke order regelnummer.</p> <pre><lineNumber> <ebcc:content>n..4</ebcc:content> <ebcc:formatText>NG</ebcc:formatText> </lineNumber> <lineNumber><ebcc:content>2</ebcc:content></lineNumber></pre>
quantity	<p>Besteld of te leveren aantal met opgave van de eenheid volgens de Edibulb eenheid (unitcode) codelijst (optioneel).</p> <pre><quantity> <ebcc:content>n..15</ebcc:content> <ebcc:unitCode>an..3</ebcc:unitCode> <ebcc:unitCodeListIdentifier>NG</ebcc:unitCodeListIdentifier> <ebcc:unitCodeListAgencyIdentifier>NG</ebcc:unitCodeListAgencyIdentifier> <ebcc:unitCodeLisAgencyNameText>NG</ebcc:unitCodeLisAgencyNameText> </quantity> <quantity> <ebcc:content>150</ebcc:content><ebcc:unitCode>27</ebcc:unitCode> </quantity></pre>
delivered-Quantity	<p>Al afgeleverd aantal met opgave van de eenheid volgens de Edibulb eenheid (unitcode) codelijst (optioneel).</p> <pre><deliveredQuantity> <ebcc:content>n..15</ebcc:content> <ebcc:unitCode>an..3</ebcc:unitCode> <ebcc:unitCodeListIdentifier>NG</ebcc:unitCodeListIdentifier> <ebcc:unitCodeListAgencyIdentifier>NG</ebcc:unitCodeListAgencyIdentifier> <ebcc:unitCodeLisAgencyNameText>NG</ebcc:unitCodeLisAgencyNameText> </deliveredQuantity> <deliveredQuantity> <ebcc:content>1</ebcc:content><ebcc:unitCode>11</ebcc:unitCode> </deliveredQuantity></pre>
toBeDelivered-Quantity	<p>Nog af te leveren aantal met opgave van de eenheid volgens de Edibulb eenheid (unitcode) codelijst (optioneel).</p> <pre><toBeDeliveredQuantity> <ebcc:content>n..15</ebcc:content> <ebcc:unitCode>an..3</ebcc:unitCode> <ebcc:unitCodeListIdentifier>NG</ebcc:unitCodeListIdentifier> <ebcc:unitCodeListAgencyIdentifier>NG</ebcc:unitCodeListAgencyIdentifier> <ebcc:unitCodeLisAgencyNameText>NG</ebcc:unitCodeLisAgencyNameText> </toBeDeliveredQuantity> <toBeDeliveredQuantity> <ebcc:content>1</ebcc:content><ebcc:unitCode>11</ebcc:unitCode> </toBeDeliveredQuantity></pre>
kindOfDelivery-Indicator	<p>Indicatie of de partij op deze regel in zijn geheel is geleverd, danwel dat na deze levering nog meer van deze partij volgt (optioneel).</p> <p>1 restpartij 3 gedeelte partij 4 gehele partij</p> <pre><kindOfDeliveryIndicator> <ebcc:content>an..3</ebcc:content> <ebcc:formatText>NG</ebcc:formatText> </kindOfDeliveryIndicator> <kindOfDeliveryIndicator> <ebcc:content>4</ebcc:content> </kindOfDeliveryIndicator></pre>
despatchDate	<p>Ophaaldatum volgens opmaak CCYYMMDDHHMM (format: 203) (optioneel).</p> <pre><despatchDate> <ebcc:content>CCYYMMDDHHMM</ebcc:content> <ebcc:formatText>203</ebcc:formatText> </despatchDate> <despatchDate> <ebcc:content>200805221030</ebcc:content> <ebcc:formatText>203</ebcc:formatText> </despatchDate></pre>
despatchLocation	<p>Plaats waar de te transporteren goederen moeten worden opgehaald (optioneel).</p> <pre><despatchLocation> <ebcc:typeCode>NG</ebcc:typeCode> <ebcc:streetBuildingIdentifier></pre>

	<pre> <ebcc:content>an..8</ebcc:content> <ebcc:schemeIdentifier>NG</ebcc:schemeIdentifier> <ebcc:schemeNameText>NG</ebcc:schemeNameText> <ebcc:schemeAgencyIdentifier>NG</ebcc:schemeAgencyIdentifier> <ebcc:schemeAgencyNameText>NG</ebcc:schemeAgencyNameText> <ebcc:schemeVersionIdentifier>NG</ebcc:schemeVersionIdentifier> <ebcc:schemeDataUniformResourceIdentifier>NG </ebcc:schemeDataUniformResourceIdentifier> <ebcc:schemeUniformResourceIdentifier>NG</ebcc:schemeUniformResourceIdentifier> </ebcc:streetBuildingIdentifier> <ebcc:streetName> <ebcc:content>an..43</ebcc:content> <ebcc:languageIdentifier>NG</ebcc:languageIdentifier> <ebcc:languageLocaleIdentifier>NG</ebcc:languageLocaleIdentifier> </ebcc:streetName> <ebcc:districtName>NG</ebcc:districtName> <ebcc:townName> <ebcc:content>an..24</ebcc:content> <ebcc:languageIdentifier>NG</ebcc:languageIdentifier> <ebcc:languageLocaleIdentifier>NG</ebcc:languageLocaleIdentifier> </ebcc:townName> <ebcc:stateIdentifier>NG</ebcc:stateIdentifier> <ebcc:postCodeIdentifier>NG</ebcc:postCodeIdentifier> <ebcc:countryCode> <ebcc:content>an..3</ebcc:content> <ebcc:listIdentifier>NG</ebcc:listIdentifier> <ebcc:listAgencyIdentifier>NG</ebcc:listAgencyIdentifier> <ebcc:listAgencyNameText>NG</ebcc:listAgencyNameText> <ebcc:listNameText>NG</ebcc:listNameText> <ebcc:listVersionIdentifier>NG</ebcc:listVersionIdentifier> <ebcc:nameText>NG</ebcc:nameText> <ebcc:languageIdentifier>NG</ebcc:languageIdentifier> <ebcc:listUniformResourceIdentifier>NG</ebcc:listUniformResourceIdentifier> <ebcc:listSchemeUniformResourceIdentifier>NG </ebcc:listSchemeUniformResourceIdentifier> </ebcc:countryCode> <ebcc:postOfficeBoxIdentifier>NG</ebcc:postOfficeBoxIdentifier> <ebcc:buildingIdentifier> <ebcc:content>an..3</ebcc:content> <ebcc:schemeIdentifier>NG</ebcc:schemeIdentifier> <ebcc:schemeNameText>NG</ebcc:schemeNameText> <ebcc:schemeAgencyIdentifier>NG</ebcc:schemeAgencyIdentifier> <ebcc:schemeAgencyNameText>NG</ebcc:schemeAgencyNameText> <ebcc:schemeVersionIdentifier>NG</ebcc:schemeVersionIdentifier> <ebcc:schemeDataUniformResourceIdentifier>NG </ebcc:schemeDataUniformResourceIdentifier> <ebcc:schemeUniformResourceIdentifier>NG</ebcc:schemeUniformResourceIdentifier> </ebcc:buildingIdentifier> <ebcc:buildingName> <ebcc:content>an..20</ebcc:content> <ebcc:languageIdentifier>NG</ebcc:languageIdentifier> <ebcc:languageLocaleIdentifier>NG</ebcc:languageLocaleIdentifier> </ebcc:buildingName> <ebcc:suiteIdentifier>NG</ebcc:suiteIdentifier> <ebcc:mailDeliverySubLocationIdentifier>NG</ebcc:mailDeliverySubLocationIdentifier> <ebcc:floorIdentifier>NG</ebcc:floorIdentifier> <ebcc:lotIdentifier>NG</ebcc:lotIdentifier> <ebcc:blockIdentifier>NG</ebcc:blockIdentifier> <ebcc:districtSubdivisionIdentifier>NG</ebcc:districtSubdivisionIdentifier> <ebcc:regionIdentifier>NG</ebcc:regionIdentifier> <ebcc:countyIdentifier>NG</ebcc:countyIdentifier> <ebcc:postalAddressFirstLineText>NG</ebcc:postalAddressFirstLineText> <ebcc:postalAddressSecondLineText>NG</ebcc:postalAddressSecondLineText> <ebcc:postalAddressThirdLineText>NG</ebcc:postalAddressThirdLineText> <ebcc:postalAddressFourthLineText>NG</ebcc:postalAddressFourthLineText> <ebcc:postalAddressFifthLineText>NG</ebcc:postalAddressFifthLineText> </despatchLocation> </pre>
transhinent-	Plaats waar de te transporteren goederen moeten worden overgeslagen

Location	<pre> <transhipmentLocation> <ebcc:typeCode>NG</ebcc:typeCode> <ebcc:streetBuildingIdentifier> <ebcc:content>an..8</ebcc:content> <ebcc:schemeIdentifier>NG</ebcc:schemeIdentifier> <ebcc:schemeNameText>NG</ebcc:schemeNameText> <ebcc:schemeAgencyIdentifier>NG</ebcc:schemeAgencyIdentifier> <ebcc:schemeAgencyNameText>NG</ebcc:schemeAgencyNameText> <ebcc:schemeVersionIdentifier>NG</ebcc:schemeVersionIdentifier> <ebcc:schemeDataUniformResourceIdentifier>NG </ebcc:schemeDataUniformResourceIdentifier> <ebcc:schemeUniformResourceIdentifier>NG</ebcc:schemeUniformResourceIdentifier> </ebcc:streetBuildingIdentifier> <ebcc:streetName> <ebcc:content>an..43</ebcc:content> <ebcc:languageIdentifier>NG</ebcc:languageIdentifier> <ebcc:languageLocaleIdentifier>NG</ebcc:languageLocaleIdentifier> </ebcc:streetName> <ebcc:districtName>NG</ebcc:districtName> <ebcc:townName> <ebcc:content>an..24</ebcc:content> <ebcc:languageIdentifier>NG</ebcc:languageIdentifier> <ebcc:languageLocaleIdentifier>NG</ebcc:languageLocaleIdentifier> </ebcc:townName> <ebcc:stateIdentifier>NG</ebcc:stateIdentifier> <ebcc:postCodeIdentifier>NG</ebcc:postCodeIdentifier> <ebcc:countryCode> <ebcc:content>an..3</ebcc:content> <ebcc:listIdentifier>NG</ebcc:listIdentifier> <ebcc:listAgencyIdentifier>NG</ebcc:listAgencyIdentifier> <ebcc:listAgencyNameText>NG</ebcc:listAgencyNameText> <ebcc:listNameText>NG</ebcc:listNameText> <ebcc:listVersionIdentifier>NG</ebcc:listVersionIdentifier> <ebcc:nameText>NG</ebcc:nameText> <ebcc:languageIdentifier>NG</ebcc:languageIdentifier> <ebcc:listUniformResourceIdentifier>NG</ebcc:listUniformResourceIdentifier> <ebcc:listSchemeUniformResourceIdentifier>NG </ebcc:listSchemeUniformResourceIdentifier> </ebcc:countryCode> <ebcc:postOfficeBoxIdentifier>NG</ebcc:postOfficeBoxIdentifier> <ebcc:buildingIdentifier> <ebcc:content>an..3</ebcc:content> <ebcc:schemeIdentifier>NG</ebcc:schemeIdentifier> <ebcc:schemeNameText>NG</ebcc:schemeNameText> <ebcc:schemeAgencyIdentifier>NG</ebcc:schemeAgencyIdentifier> <ebcc:schemeAgencyNameText>NG</ebcc:schemeAgencyNameText> <ebcc:schemeVersionIdentifier>NG</ebcc:schemeVersionIdentifier> <ebcc:schemeDataUniformResourceIdentifier>NG </ebcc:schemeDataUniformResourceIdentifier> <ebcc:schemeUniformResourceIdentifier>NG</ebcc:schemeUniformResourceIdentifier> </ebcc:buildingIdentifier> <ebcc:buildingName> <ebcc:content>an..20</ebcc:content> <ebcc:languageIdentifier>NG</ebcc:languageIdentifier> <ebcc:languageLocaleIdentifier>NG</ebcc:languageLocaleIdentifier> </ebcc:buildingName> <ebcc:suiteIdentifier>NG</ebcc:suiteIdentifier> <ebcc:mailDeliverySubLocationIdentifier>NG</ebcc:mailDeliverySubLocationIdentifier> <ebcc:floorIdentifier>NG</ebcc:floorIdentifier> <ebcc:lotIdentifier>NG</ebcc:lotIdentifier> <ebcc:blockIdentifier>NG</ebcc:blockIdentifier> <ebcc:districtSubdivisionIdentifier>NG</ebcc:districtSubdivisionIdentifier> <ebcc:regionIdentifier>NG</ebcc:regionIdentifier> <ebcc:countyIdentifier>NG</ebcc:countyIdentifier> <ebcc:postalAddressFirstLineText>NG</ebcc:postalAddressFirstLineText> <ebcc:postalAddressSecondLineText>NG</ebcc:postalAddressSecondLineText> <ebcc:postalAddressThirdLineText>NG</ebcc:postalAddressThirdLineText> <ebcc:postalAddressFourthLineText>NG</ebcc:postalAddressFourthLineText> <ebcc:postalAddressFifthLineText>NG</ebcc:postalAddressFifthLineText> </transhipmentLocation> </pre>
----------	---

	<pre> <transhipmentLocation> <ebcc:streetBuildingIdentifier><ebcc:content>55</ebcc:content></ebcc:streetBuildingIdentifier> <ebcc:streetName><ebcc:content>Overslag</ebcc:content></ebcc:streetName> <ebcc:townName><ebcc:content>Leiden</ebcc:content></ebcc:townName> <ebcc:countryCode> <ebcc:content>NLD</ebcc:content> </ebcc:countryCode> <ebcc:buildingIdentifier> <ebcc:content>3</ebcc:content> </ebcc:buildingIdentifier> <ebcc:buildingName> <ebcc:content>Loods</ebcc:content> </ebcc:buildingName> </transhipmentLocation> </pre>
deliveryDate	<pre> Leverdatum volgens opmaak CCYYMMDDHHMM (format:203). <deliveryDate> <ebcc:content>CCYYMMDDHHMM</ebcc:content> <ebcc:formatText>203</ebcc:formatText> </deliveryDate> <deliveryDate> <ebcc:content>200302011100</ebcc:content><ebcc:formatText>203</ebcc:formatText> </deliveryDate> </pre>
deliveryLocation	<pre> Plaats waar de te transporteren goederen moeten worden afgeleverd. <deliveryLocation> <ebcc:typeCode>NG</ebcc:typeCode> <ebcc:streetBuildingIdentifier> <ebcc:content>an.. 8</ebcc:content> <ebcc:schemeIdentifier>NG</ebcc:schemeIdentifier> <ebcc:schemeNameText>NG</ebcc:schemeNameText> <ebcc:schemeAgencyIdentifier>NG</ebcc:schemeAgencyIdentifier> <ebcc:schemeAgencyNameText>NG</ebcc:schemeAgencyNameText> <ebcc:schemeVersionIdentifier>NG</ebcc:schemeVersionIdentifier> <ebcc:schemeDataUniformResourceIdentifier>NG </ebcc:schemeDataUniformResourceIdentifier> <ebcc:schemeUniformResourceIdentifier>NG</ebcc:schemeUniformResourceIdentifier> </ebcc:streetBuildingIdentifier> <ebcc:streetName> <ebcc:content>an..43</ebcc:content> <ebcc:languageIdentifier>NG</ebcc:languageIdentifier> <ebcc:languageLocaleIdentifier>NG</ebcc:languageLocaleIdentifier> </ebcc:streetName> <ebcc:districtName>NG</ebcc:districtName> <ebcc:townName> <ebcc:content>an..24</ebcc:content> <ebcc:languageIdentifier>NG</ebcc:languageIdentifier> <ebcc:languageLocaleIdentifier>NG</ebcc:languageLocaleIdentifier> </ebcc:townName> <ebcc:stateIdentifier>NG</ebcc:stateIdentifier> <ebcc:postCodeIdentifier>NG</ebcc:postCodeIdentifier> <ebcc:countryCode> <ebcc:content>an..3</ebcc:content> <ebcc:listIdentifier>NG</ebcc:listIdentifier> <ebcc:listAgencyIdentifier>NG</ebcc:listAgencyIdentifier> <ebcc:listAgencyNameText>NG</ebcc:listAgencyNameText> <ebcc:listNameText>NG</ebcc:listNameText> <ebcc:listVersionIdentifier>NG</ebcc:listVersionIdentifier> <ebcc:nameText>NG</ebcc:nameText> <ebcc:languageIdentifier>NG</ebcc:languageIdentifier> <ebcc:listUniformResourceIdentifier>NG</ebcc:listUniformResourceIdentifier> <ebcc:listSchemeUniformResourceIdentifier>NG </ebcc:listSchemeUniformResourceIdentifier> </ebcc:countryCode> <ebcc:postOfficeBoxIdentifier>NG</ebcc:postOfficeBoxIdentifier> <ebcc:buildingIdentifier> <ebcc:content>an..3</ebcc:content> <ebcc:schemeIdentifier>NG</ebcc:schemeIdentifier> <ebcc:schemeNameText>NG</ebcc:schemeNameText> <ebcc:schemeAgencyIdentifier>NG</ebcc:schemeAgencyIdentifier> <ebcc:schemeAgencyNameText>NG</ebcc:schemeAgencyNameText> </pre>

	<pre> <ebcc:schemeVersionIdentifier>NG</ebcc:schemeVersionIdentifier> <ebcc:schemeDataUniformResourceIdentifier>NG </ebcc:schemeDataUniformResourceIdentifier> <ebcc:schemeUniformResourceIdentifier>NG</ebcc:schemeUniformResourceIdentifier> </ebcc:buildingIdentifier> <ebcc:buildingName> <ebcc:content>an..20</ebcc:content> <ebcc:languageIdentifier>NG</ebcc:languageIdentifier> <ebcc:languageLocaleIdentifier>NG</ebcc:languageLocaleIdentifier> </ebcc:buildingName> <ebcc:suiteIdentifier>NG</ebcc:suiteIdentifier> <ebcc:mailDeliverySubLocationIdentifier>NG</ebcc:mailDeliverySubLocationIdentifier> <ebcc:floorIdentifier>NG</ebcc:floorIdentifier> <ebcc:lotIdentifier>NG</ebcc:lotIdentifier> <ebcc:blockIdentifier>NG</ebcc:blockIdentifier> <ebcc:districtSubdivisionIdentifier>NG</ebcc:districtSubdivisionIdentifier> <ebcc:regionIdentifier>NG</ebcc:regionIdentifier> <ebcc:countyIdentifier>NG</ebcc:countyIdentifier> <ebcc:postalAddressFirstLineText>NG</ebcc:postalAddressFirstLineText> <ebcc:postalAddressSecondLineText>NG</ebcc:postalAddressSecondLineText> <ebcc:postalAddressThirdLineText>NG</ebcc:postalAddressThirdLineText> <ebcc:postalAddressFourthLineText>NG</ebcc:postalAddressFourthLineText> <ebcc:postalAddressFifthLineText>NG</ebcc:postalAddressFifthLineText> </deliveryLocation> </pre>
	<pre> <deliveryLocation> <ebcc:streetBuildingIdentifier> <ebcc:content>10</ebcc:content> </ebcc:streetBuildingIdentifier> <ebcc:streetName> <ebcc:content>Achterbuurt</ebcc:content> </ebcc:streetName> <ebcc:townName> <ebcc:content>Rotterdam</ebcc:content> </ebcc:townName> <ebcc:countryCode> <ebcc:content>NLD</ebcc:content> </ebcc:countryCode> <ebcc:buildingIdentifier> <ebcc:content>3</ebcc:content> </ebcc:buildingIdentifier> <ebcc:buildingName> <ebcc:content>Koelcel</ebcc:content> </ebcc:buildingName> </deliveryLocation> </pre>
conditionCode	<p>Conditie volgens Edibulb conditiescodelijst (optioneel nx)</p> <pre> <conditionCode> <ebcc:content>an..3</ebcc:content> <ebcc:schemeIdentifier>NG</ebcc:schemeIdentifier> <ebcc:schemeNameText>NG</ebcc:schemeNameText> <ebcc:schemeAgencyIdentifier>NG</ebcc:schemeAgencyIdentifier> <ebcc:schemeAgencyNameText>NG</ebcc:schemeAgencyNameText> <ebcc:schemeVersionIdentifier>NG</ebcc:schemeVersionIdentifier> <ebcc:schemeDataUniformResourceIdentifier>NG< /ebcc:schemeDataUniformResourceIdentifier> <ebcc:schemeUniformResourceIdentifier>NG< /ebcc:schemeUniformResourceIdentifier> </conditionCode> <conditionCode> <ebcc:content>388</ebcc:content> </conditionCode> </pre>
freetext (0..2)	<p>Vrije tekst voor condities die niet gecodeerd kunnen worden of zijn (optioneel).</p> <pre> <freeText> <ebcc:content>an..80</ebcc:content> <ebcc:languageIdentifier>NG</ebcc:languageIdentifier> <ebcc:languageLocaleIdentifier>NG</ebcc:languageLocaleIdentifier> </freeText> <freetext><ebcc:content>Opmerking 1</ebcc:content></freetext> <freetext><ebcc:content>Wijziging op eerdere afspraak</ebcc:content></freetext> </pre>

palletDetails	Pallettype volgens Edibulb codelijst voor emballage met aantal stuks <pre> <dt:packagingDetails> <ebcc:typeCode> <ebcc:content>n3</ebcc:content> <ebcc:listIdentifier>NG</ebcc:listIdentifier> <ebcc:listAgencyIdentifier>NG</ebcc:listAgencyIdentifier> <ebcc:listAgencyNameText>NG</ebcc:listAgencyNameText> <ebcc:listNameText>NG</ebcc:listNameText> <ebcc:listVersionIdentifier>NG</ebcc:listVersionIdentifier> <ebcc:nameText>NG</ebcc:nameText> <ebcc:languageIdentifier>NG</ebcc:languageIdentifier> <ebcc:listUniformResourceIdentifier>NG</ebcc:listUniformResourceIdentifier> <ebcc:listSchemeUniformResourceIdentifier>NG </ebcc:typeCode> <ebcc:objectCountValue> <ebcc:content>n..8</ebcc:content> <ebcc:formatText>NG</ebcc:formatText> </ebcc:objectCountValue> <ebcc:positionObjectCode>NG</ebcc:positionObjectCode> <ebcc:materialCode>NG</ebcc:materialCode> </dt:packagingDetails> </pre>
	<pre> <dt:packagingDetails> <ebcc:typeCode><ebcc:content>6</ebcc:content></ebcc:typeCode> <ebcc:objectCountValue><ebcc:content>2</ebcc:content></ebcc:objectCountValue> </dt:packagingDetails> </pre>

3.1.3.8.1 Element logistiekeOrder/lineltemDetails/transportUnits

Element welke een volledige beschrijving van de georderde of te leveren transporteenheden bevat.

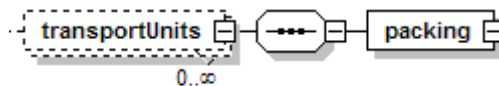

Element	Waarde
transport-Units(n)	Komt zoveel voor als nodig om de bestelling / transportopdracht / levering te beschrijven (zie ook packing).
	<pre> <transportUnits> <packing> </packing> </transportUnits> </pre>

3.1.3.8.1.1 Element logistiekeOrder/lineltemDetails/transportUnits/packing

Element welke de volledige te bestellen of te leveren goederen (fust of product) o.b.v. verpakking bevat. Binnen de verpakking kunnen weer meerdere elementen voorkomen die een verdere verfijning van de verpakking mogelijk maken. Door deze gelaagtheid is het mogelijk alle onderdelen van de verpakking (indien nodig) in detail te beschrijven waarbij de identiteit en de positie van elk onderdeel van de verpakking bekend is.

De gedetailleerdheid is echter niet nodig; ook op hoog niveau kunnen de belangrijke gegevens van de verpakking al worden beschreven.

B.v. het is mogelijk aan te geven dat er 3 pallets met 50 fusten moeten worden geleverd, maar het is ook mogelijk om van elke pallet iedere fust apart te beschrijven waarbij iedere fust uniek geïdentificeerd kan worden.

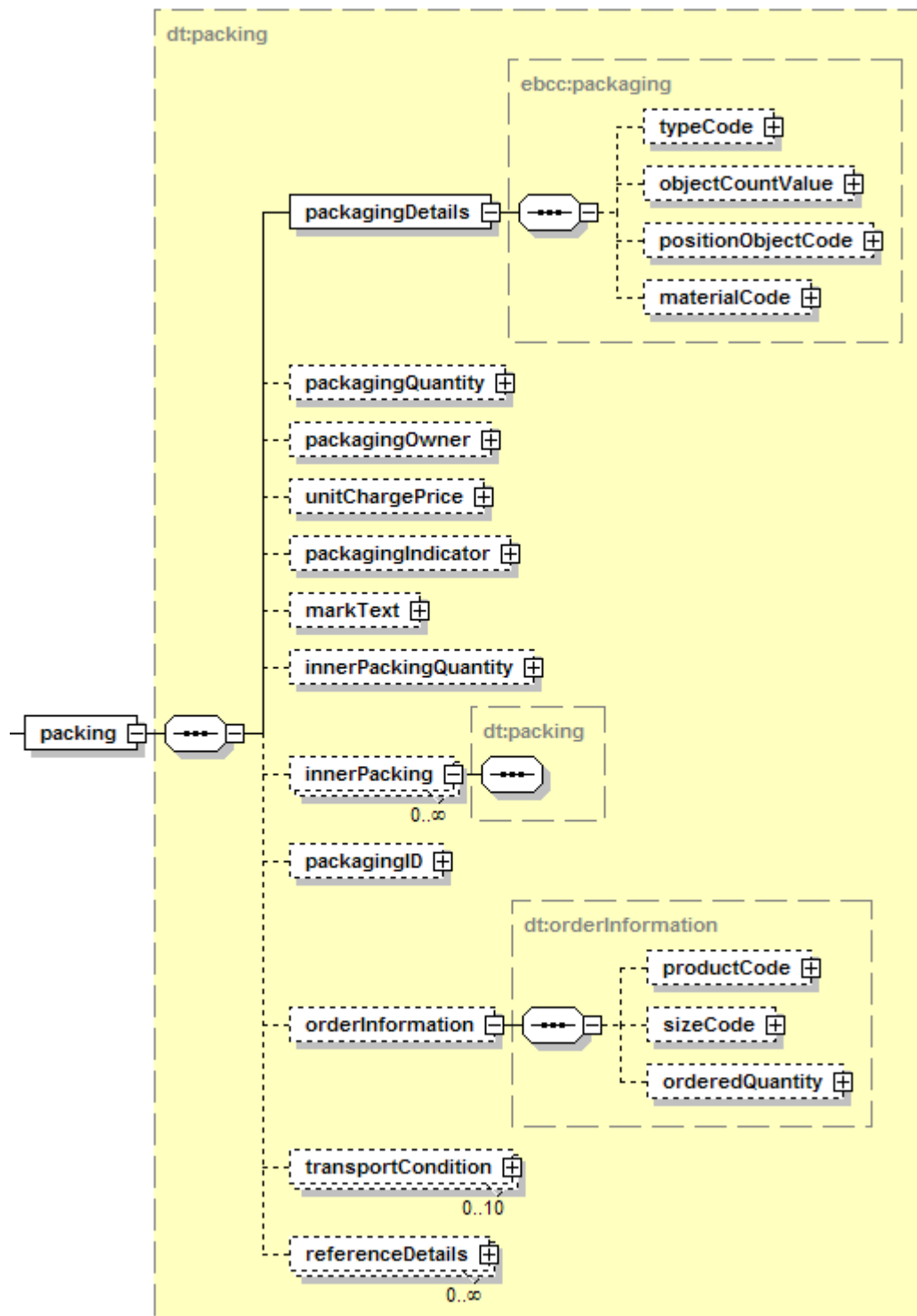

Element	Waarde
packagingDetails	Ptype volgens Edibulb codelijst voor emballage met aantal stuks <dt:packagingDetails> <ebcc:typeCode> <ebcc:content>n3</ebcc:content> <ebcc:listIdentifier>NG</ebcc:listIdentifier> <ebcc:listAgencyIdentifier>NG</ebcc:listAgencyIdentifier> <ebcc:listAgencyNameText>NG</ebcc:listAgencyNameText> <ebcc:listNameText>NG</ebcc:listNameText> <ebcc:listVersionIdentifier>NG</ebcc:listVersionIdentifier>

	<pre> <ebcc:nameText>NG</ebcc:nameText> <ebcc:languageIdentifier>NG</ebcc:languageIdentifier> <ebcc:listUniformResourceIdentifier>NG</ebcc:listUniformResourceIdentifier> <ebcc:listSchemeUniformResourceIdentifier>NG </ebcc:listSchemeUniformResourceIdentifier> </ebcc:typeCode> <ebcc:objectCountValue> <ebcc:content>n..8</ebcc:content> <ebcc:formatText>NG</ebcc:formatText> </ebcc:objectCountValue> <ebcc:positionObjectCode>NG</ebcc:positionObjectCode> <ebcc:materialCode>NG</ebcc:materialCode> </dt:packagingDetails> <dt:packagingDetails> <ebcc:typeCode><ebcc:content>6</ebcc:content></ebcc:typeCode> <ebcc:objectCountValue><ebcc:content>2</ebcc:content></ebcc:objectCountValue> </dt:packagingDetails> </pre>
packagingQuantity	<p>Aantal per eenheid. Inhoud per emballagesoort (M, n..15) (optioneel).</p> <pre> <dt:packagingQuantity> <ebcc:content>n..15</ebcc:content> <ebcc:unitCode>NG</ebcc:unitCode> <ebcc:unitCodeListIdentifier>NG</ebcc:unitCodeListIdentifier> <ebcc:unitCodeListAgencyIdentifier>NG</ebcc:unitCodeListAgencyIdentifier> <ebcc:unitCodeListAgencyNameText>NG </ebcc:unitCodeListAgencyNameText> </dt:packagingQuantity> <dt:packagingQuantity><ebcc:content>500</ebcc:content></dt:packagingQuantity> </pre>
packagingOwner	<p>Unieke identificatie van de fusteigenaar middels Edibulb NAW code en type CW. Optioneel segment waarin het nummer van de fusteigenaar wordt vermeld. Er mag maximaal 1 nummer worden ingevoerd per fusttype (optioneel).</p> <pre> <dt:packagingOwner> <dt:partyDetails> <ebcc:identifier><ebcc:content>n5</ebcc:content></ebcc:identifier> <ebcc:typeCode><ebcc:content>CW</ebcc:content></ebcc:typeCode> </dt:partyDetails> </dt:packagingOwner> <dt:packagingOwner> <dt:partyDetails> <ebcc:identifier><ebcc:content>09370</ebcc:content></ebcc:identifier> <ebcc:typeCode><ebcc:content>CW</ebcc:content></ebcc:typeCode> </dt:partyDetails> </dt:packagingOwner> </pre>
unitChargePrice	<p>Optioneel segment waarin de emballageprijs voor een emballagesoort wordt vermeld. Mag per regel meerdere keren voorkomen, maar slechts 1 keer per soort emballage worden gebruikt (optioneel).</p> <pre> <dt:unitChargePrice> <ebcc:amount> <ebcc:content>n..15</ebcc:content> <ebcc:currencyIdentifier>NG</ebcc:currencyIdentifier> <ebcc:currencyCodeListVersionIdentifier>NG </ebcc:currencyCodeListVersionIdentifier> </ebcc:amount> <ebcc:baseChargePriceQuantity>NG</ebcc:baseChargePriceQuantity> <ebcc:chargeableQuantity> <ebcc:content>n..8</ebcc:content> <ebcc:unitCode>NG</ebcc:unitCode> <ebcc:unitCodeListIdentifier>NG</ebcc:unitCodeListIdentifier> <ebcc:unitCodeListAgencyIdentifier>NG</ebcc:unitCodeListAgencyIdentifier> <ebcc:unitCodeListAgencyNameText>NG</ebcc:unitCodeListAgencyNameText> </ebcc:chargeableQuantity> </dt:unitChargePrice> <dt:unitChargePrice> <ebcc:amount><ebcc:Content>2.50</ebcc:Content></ebcc:amount> <ebcc:chargeableQuantity><ebcc:content>2</ebcc:content></ebcc:chargeableQuantity> </dt:unitChargePrice> </pre>
packagingIndicator	<p>Leeg/Vol/Restant indicatie. Indicatie of de inhoud genoemd in packagingQuantity een volle inhoud (5), een lege inhoud (4) of een gedeeltelijke inhoud (7) betreft (M, an1) (optioneel).</p> <p>4 Empty 5 Full</p>

	<p>7 Partial filled</p> <pre><dt:packagingIndicator> <ebcc:content>an1</ebcc:content> <ebcc:formatText>NG</ebcc:formatText> </dt:packagingIndicator> <dt:packagingIndicator><ebcc:content>5</ebcc:content></dt:packagingIndicator></pre>
markText	<p>Merk of Opschrift of Barcode. Optioneel segment, waarin het merk emballage (of opschrift op de emballage) wordt vermeld. Dit segment mag meerdere keren worden gebruikt, maar per soort emballage slechts 1 keer (optioneel).</p> <pre><dt:markText> <ebcc:content>an..70</ebcc:content> <ebcc:languageIdentifier>NG</ebcc:languageIdentifier> <ebcc:languageLocaleIdentifier>NG</ebcc:languageLocaleIdentifier> </dt:markText> <dt:markText><ebcc:content>12345678901</ebcc:content></dt:markText></pre>
innerPackingQuantity	<p>Alleen ingevuld wanneer innerPacking niet is ingevuld. Bevat het aantal eenheden op de in dit segment beschreven emballage (optioneel).</p> <pre><dt:innerPackingQuantity> <ebcc:content>n..8</ebcc:content> <ebcc:unitCode>an..3</ebcc:unitCode> <ebcc:unitCodeListIdentifier>NG</ebcc:unitCodeListIdentifier> <ebcc:unitCodeListAgencyIdentifier>NG</ebcc:unitCodeListAgencyIdentifier> <ebcc:unitCodeListAgencyNameText>NG</ebcc:unitCodeListAgencyNameText> </dt:innerPackingQuantity> <dt:innerPackingQuantity> <ebcc:content>5</ebcc:content><ebcc:unitCode>45</ebcc:unitCode> </dt:innerPackingQuantity></pre>
innerPacking	<p>Hierarchische beschrijving van de emballage die aanwezig is op de in dit segment beschreven emballage (optioneel). De structuur is gelijk aan de structuur van het hoger liggende niveau.</p> <pre><dt:innerPacking> <dt:packagingDetails> <ebcc:typeCode> <ebcc:content>n3</ebcc:content> <ebcc:listIdentifier>NG</ebcc:listIdentifier> <ebcc:listAgencyIdentifier>NG</ebcc:listAgencyIdentifier> <ebcc:listAgencyNameText>NG</ebcc:listAgencyNameText> <ebcc:listNameText>NG</ebcc:listNameText> <ebcc:listVersionIdentifier>NG</ebcc:listVersionIdentifier> <ebcc:nameText>NG</ebcc:nameText> <ebcc:languageIdentifier>NG</ebcc:languageIdentifier> <ebcc:listUniformResourceIdentifier>NG </ebcc:listUniformResourceIdentifier> <ebcc:listSchemeUniformResourceIdentifier>NG </ebcc:listSchemeUniformResourceIdentifier> </ebcc:typeCode> <ebcc:objectCountValue> <ebcc:content>n..8</ebcc:content> <ebcc:formatText>NG</ebcc:formatText> </ebcc:objectCountValue> <ebcc:positionObjectCode>NG</ebcc:positionObjectCode> <ebcc:materialCode>NG</ebcc:materialCode> </dt:packagingDetails> <dt:packagingQuantity> <ebcc:content>n..15</ebcc:content> <ebcc:unitCode>NG</ebcc:unitCode> <ebcc:unitCodeListIdentifier>NG</ebcc:unitCodeListIdentifier> <ebcc:unitCodeListAgencyIdentifier>NG</ebcc:unitCodeListAgencyIdentifier> <ebcc:unitCodeListAgencyNameText>NG</ebcc:unitCodeListAgencyNameText> </dt:packagingQuantity> <dt:packagingOwner></dt:packagingOwner> <dt:unitChargePrice> <ebcc:amount> <ebcc:content>n..15</ebcc:content> <ebcc:currencyIdentifier>NG</ebcc:currencyIdentifier> <ebcc:currencyCodeListVersionIdentifier>NG </ebcc:currencyCodeListVersionIdentifier> </ebcc:amount> <ebcc:baseChargePriceQuantity>NG</ebcc:baseChargePriceQuantity></pre>

	<pre> <ebcc:chargeableQuantity> <ebcc:content>n..8</ebcc:content> <ebcc:unitCode>NG</ebcc:unitCode> <ebcc:unitCodeListIdentifier>NG</ebcc:unitCodeListIdentifier> <ebcc:unitCodeListAgencyIdentifier>NG </ebcc:unitCodeListAgencyIdentifier> <ebcc:unitCodeLisAgencyNameText>NG </ebcc:unitCodeLisAgencyNameText> </ebcc:chargeableQuantity> </dt:unitChargePrice> <dt:packagingIndicator> <ebcc:content>an1</ebcc:content> <ebcc:formatText>NG</ebcc:formatText> </dt:packagingIndicator> <dt:markText> <ebcc:content>an..70</ebcc:content> <ebcc:languageIdentifier>NG</ebcc:languageIdentifier> <ebcc:languageLocaleIdentifier>NG</ebcc:languageLocaleIdentifier> </dt:markText> <dt:innerPackingQuantity> <ebcc:content>n..8</ebcc:content> <ebcc:unitCode>an..3</ebcc:unitCode> <ebcc:unitCodeListIdentifier>NG</ebcc:unitCodeListIdentifier> <ebcc:unitCodeListAgencyIdentifier>NG</ebcc:unitCodeListAgencyIdentifier> <ebcc:unitCodeLisAgencyNameText>NG</ebcc:unitCodeLisAgencyNameText> </dt:innerPackingQuantity> <dt:innerPacking>.....</dt:innerPacking> <dt:packagingID> <ebcc:content>an..128</ebcc:content> <ebcc:schemelIdentifier>an..15</ebcc:schemelIdentifier> <ebcc:schemeNameText>NG</ebcc:schemeNameText> <ebcc:schemeAgencyIdentifier>NG</ebcc:schemeAgencyIdentifier> <ebcc:schemeAgencyNameText>NG</ebcc:schemeAgencyNameText> <ebcc:schemeVersionIdentifier>NG</ebcc:schemeVersionIdentifier> <ebcc:schemeDataUniformResourceIdentifier>NG </ebcc:schemeDataUniformResourceIdentifier> <ebcc:schemeUniformResourceIdentifier>NG </ebcc:schemeUniformResourceIdentifier> </dt:packagingID> </dt:innerPacking> </pre>
packaging ID	<p>Unieke identificatie van de emballage (b.v. via GRAI code) . De identificatie kan eventueel bij automatische (verdeel)processen worden gebruikt (RFID, EAN128 Barcode, ...) (optioneel).</p> <pre> <dt:packagingID> <ebcc:content>an..128</ebcc:content> <ebcc:schemelIdentifier>an..15</ebcc:schemelIdentifier> <ebcc:schemeNameText>NG</ebcc:schemeNameText> <ebcc:schemeAgencyIdentifier>NG</ebcc:schemeAgencyIdentifier> <ebcc:schemeAgencyNameText>NG</ebcc:schemeAgencyNameText> <ebcc:schemeVersionIdentifier>NG</ebcc:schemeVersionIdentifier> <ebcc:schemeDataUniformResourceIdentifier>NG </ebcc:schemeDataUniformResourceIdentifier> <ebcc:schemeUniformResourceIdentifier>NG </ebcc:schemeUniformResourceIdentifier> </dt:packagingID> <dt:packagingID> <ebcc:content>2510</ebcc:content> <ebcc:schemelIdentifier>Europallet</ebcc:schemelIdentifier> </dt:packagingID> </pre>
orderInformation	<p>Informatie over de order waar dit verpakkingselement betrekking op heeft. Dit is opgebouwd uit gegevens over de productCode, de sizeCode en de orderedQuantity. De productCode volgens de Edibulb cultivarcodelijst. sizeCode (maat van het product) volgens de Edibulb maatcodelijst. orderedQuantity (gekocht aantal met eenheid volgens Edibulb eenheid (unitcode) codelijst.</p> <pre> <dt:orderInformation> <dt:productCode> <ebcc:content>n..7</ebcc:content> <ebcc:listIdentifier>NG</ebcc:listIdentifier> <ebcc:listAgencyIdentifier>NG</ebcc:listAgencyIdentifier> </pre>

	<pre> <ebcc:listAgencyNameText>NG</ebcc:listAgencyNameText> <ebcc:listNameText>NG</ebcc:listNameText> <ebcc:listVersionIdentifier>NG</ebcc:listVersionIdentifier> <ebcc:nameText>an..35</ebcc:nameText> <ebcc:languageIdentifier>NG</ebcc:languageIdentifier> <ebcc:listUniformResourceIdentifier>NG</ebcc:listUniformResourceIdentifier> <ebcc:listSchemeUniformResourceIdentifier>NG </ebcc:listSchemeUniformResourceIdentifier> </dt:productCode> <dt:sizeCode> <ebcc:content>n..4</ebcc:content> <ebcc:listIdentifier>NG</ebcc:listIdentifier> <ebcc:listAgencyIdentifier>NG</ebcc:listAgencyIdentifier> <ebcc:listAgencyNameText>NG</ebcc:listAgencyNameText> <ebcc:listNameText>NG</ebcc:listNameText> <ebcc:listVersionIdentifier>NG</ebcc:listVersionIdentifier> <ebcc:nameText>NG</ebcc:nameText> <ebcc:languageIdentifier>NG</ebcc:languageIdentifier> <ebcc:listUniformResourceIdentifier>NG</ebcc:listUniformResourceIdentifier> <ebcc:listSchemeUniformResourceIdentifier>NG </ebcc:listSchemeUniformResourceIdentifier> </dt:sizeCode> <dt:orderedQuantity> <ebcc:content>n..15</ebcc:content> <ebcc:unitCode>an..3</ebcc:unitCode> <ebcc:unitCodeListIdentifier>NG</ebcc:unitCodeListIdentifier> <ebcc:unitCodeListAgencyIdentifier>NG</ebcc:unitCodeListAgencyIdentifier> <ebcc:unitCodeListAgencyNameText>NG</ebcc:unitCodeListAgencyNameText> </dt:orderedQuantity> </dt:orderInformation> </pre>
	<pre> <dt:orderInformation> <dt:productCode> <ebcc:content>9839</ebcc:content> </dt:productCode> <dt:sizeCode> <ebcc:content>867</ebcc:content> </dt:sizeCode> <dt:orderedQuantity> <ebcc:content>100</ebcc:content> <ebcc:unitCode>11</ebcc:unitCode> </dt:orderedQuantity> </dt:orderInformation> </pre>
transportCondi- tion(0..10)	<p>Transportcondities (optioneel) In dit segment kunnen de transportcondities (b.v. max. temperatuur, min. temperatuur, relatieve vochtigheid, ...) worden vastgelegd (Edibulb eenhedenlijst)</p> <pre> <transportCondition> <ebcc:content>n3</ebcc:content> <ebcc:unitCode>an..3</ebcc:unitCode> <ebcc:unitCodeListVersionIdentifier>NG</ebcc:unitCodeListVersionIdentifier> </transportCondition> <transportCondition> <ebcc:content>5</ebcc:content> <ebcc:unitCode>48</ebcc:unitCode> </transportCondition> <transportCondition> <ebcc:content>10</ebcc:content> <ebcc:unitCode>50</ebcc:unitCode> </transportCondition> </pre>
referenceDetails (nX)	<p>Referenties naar de messageIdentifier van voorgaande gerelateerde berichten.</p> <pre> <referenceDetails> <dt:referenceIdentifier> <ebcc:content>an..10</ebcc:content> <ebcc:schemeIdentifier>an..3</ebcc:schemeIdentifier> <ebcc:schemeNameText>NG</ebcc:schemeNameText> <ebcc:schemeAgencyIdentifier>n..5</ebcc:schemeAgencyIdentifier> <ebcc:schemeAgencyNameText>NG</ebcc:schemeAgencyNameText> <ebcc:schemeVersionIdentifier>an..4</ebcc:schemeVersionIdentifier> <ebcc:schemeDataUniformResourceIdentifier>NG </ebcc:schemeDataUniformResourceIdentifier> </pre>

<pre> <ebcc:schemeUniformResourceIdentifier>NG </ebcc:schemeUniformResourceIdentifier> </dt:referenceIdentifier> <dt:lineNumber> <ebcc:content>n..4</ebcc:content><ebcc:formatText>NG</ebcc:formatText> </dt:lineNumber> </referenceDetails> </referenceDetails> <dt:referenceIdentifier> <ebcc:content>0003046564</ebcc:content> <ebcc:schemelIdentifier>ON</ebcc:schemelIdentifier> <ebcc:schemeAgencyIdentifier>10253</ebcc:schemeAgencyIdentifier> <ebcc:schemeVersionIdentifier>ON20</ebcc:schemeVersionIdentifier> </dt:referenceIdentifier> <dt:lineNumber><ebcc:content>1</ebcc:content></dt:lineNumber> </referenceDetails> </pre>

3.1.4 Beveiliging

Voor de diverse berichten gebaseerd op het logistiekeOrder bericht is het van belang dat de oorsprong van het bericht vast staat. De order dient dan ook in zijn geheel te worden “getekend” met een XML Signature (<http://www.w3.org/TR/xmlsig-core/>) in de ebXML header zoals de ebXML standaard deze voorschrijft.

Voor de XML Pilot zal de digitale handtekening vooralsnog buiten beschouwing worden gelaten.

3.2 Error Bericht

3.2.1 Gebruikte componenten

Module	Bron	Referentie	V/O
errorlist	ebXML Header	http://www.oasis-open.org/committees/ebxml-msg/schema/msg-header-2_0.xsd	IO

3.2.2 Berichtstructuur error

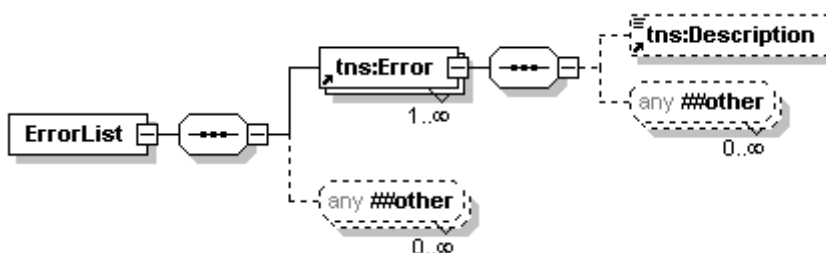

3.2.3 Berichtafspraken error

Het error bericht bevat geen body en zal in de transport header worden afgehandeld volgens de ebXML standaard (zie 3.1.1.2). De header bevat een ErrorList element met één of meerdere Error elementen.

Voor de pilot zal nog geen gebruik worden gemaakt van het errorbericht.

3.2.3.1 Element Errorlist/Error

Het error-element bevat de volgende attributen:

- id = het id van het ebXML element dat de fout bevat.
- codeContext = verwijzing naar de error codelijst
- errorCode = foutcode
- severity = Warning (doorgaan) of Error (stoppen)
- location = foutlocatie als Xpointer naar het element die fout is, of als "cid" als het de inhoud van het bericht betreft, waarbij de "cid" het attachment aangeeft welke de fout bevat.

Indien de fout op applicatieniveau is wordt het error element als volgt ingevuld:

```
<eb:ErrorList eb:id="UMRL01" eb:version="2.0" SOAP:mustUnderstand="1" eb:highestSeverity="error">
  <eb:Error eb:id="EABE01"
    eb:codeContext="urn:edibulb:eab:errors"
    eb:errorCode="WrongIdentifier"
    eb:severity="Warning"
    eb:location="cid:message:supplierparty:identificer:content">
    < eb:Description lang="nl">EAB</ eb:Description>
  </ eb:Error>
</ eb:ErrorList>
```

3.2.4 Beveiliging

Gezien de inhoud van het error bericht, is beveiliging niet gewenst, daar het bericht foutmeldingen kunnen bevatten die verwijzen naar de gebruikte beveiliging methoden.

3.3 Acknowledge Bericht

3.3.1 Gebruikte componenten

Geen.

3.3.2 Berichtstructuur acknowledge

Geen.

3.3.3 Berichtafspraken acknowledge

Het acknowledge bericht bevat geen body en zal in de transporthead worden afgehandeld volgens de ebXML standaard, waarbij het RefToMessageID (zie 3.1.1.1) is gevuld met het MessageID van het bericht waarop de bevestiging slaat. Zie ook de ebMS2 § 6.3.2.7.

Voor de pilot zal nog geen gebruik worden gemaakt van het acknowledge bericht.

3.3.4 Beveiliging

Gezien de inhoud van het acknowledge bericht, is beveiliging niet noodzakelijk.

4 Transport

4.1 Pilot

Voor de pilot zal geen gebruik worden gemaakt van SOAP/EbXML headers. De XML payload zal als attachement per email worden verzonden.

De hierna volgende paragrafen beschrijven dan ook de uiteindelijke ideaal situatie, zodat waar mogelijk hiermee wel rekening kan worden gehouden in het ontwerp.

4.2 Invulinstructie SOAP Envelop

De SOAP Envelop bevat minimaal de volgende onderdelen:

- **Verwijzingen naar de SOAP standaard en de ebXML standaard envelop.**
- **SOAP Header**
- **SOAP Body**

Voorbeeld:

```
<SOAP:Envelope xmlns:SOAP="http://schemas.xmlsoap.org/soap/envelope/"
  xmlns:xsi="http://www.w3.org/2001/XMLSchema-instance"
  xsi:schemaLocation="http://schemas.xmlsoap.org/soap/envelope/
  http://www.oasis-open.org/committees/ebxml-msg/schema/envelope.xsd">

  <SOAP:Header
    xmlns:eb="http://www.oasis-open.org/committees/ebxml-msg/schema/msg-header-2_0.xsd"
    xsi:schemaLocation="http://www.oasis-open.org/committees/ebxml-msg/schema/msg-header-2_0.xsd
    http://www.oasis-open.org/committees/ebxml-msg/schema/msg-header-2_0.xsd">
    <eb:MessageHeader ...>
    ...
    </eb:MessageHeader>
  </SOAP:Header>

  <SOAP:Body
    xmlns:eb="http://www.oasis-open.org/committees/ebxml-msg/schema/msg-header-2_0.xsd"
    xsi:schemaLocation="http://www.oasis-open.org/committees/ebxml-msg/schema/msg-header-2_0.xsd
    http://www.oasis-open.org/committees/ebxml-msg/schema/msg-header-2_0.xsd">
    <eb:Manifest eb:version="2.0">
    ...
    </eb:Manifest>
  </SOAP:Body>

</SOAP:Envelope>
```

4.2.1 SOAP Header

4.2.1.1 ebXML messageheader

De message header bevat de volgende onderdelen: (**VET**=Verplicht)

- **From** = Afzender van het bericht
- **To** = ontvanger van het bericht
- **CPAId** = Concerned Party Agreement is een verwijzing naar een contract tussen de partijen waarin zij hebben aangegeven dat zij dit berichttype met elkaar uitwisselen.
- **ConversationID** = Conversatie identificatie uniek per "gesprek"
- **Service** = Dienst waaraan de berichtinhoud wordt aangeboden.
- **Action** = De actie die de dienst dient uit te voeren met de berichtinhoud.
- **MessageData** = unieke identificatie van het bericht:
 - **MessageID** = identificatie volgens de RFC2822 standaard
 - **Timestamp** = DatumTijd van creatie header volgens XML datetime type
 - **RefToMessageID** = MessageID van een gerelateerd voorafgaand bericht

- TimeToLive = Tijd dat het bericht afgeleverd moet zijn. Berichten na deze tijd zijn niet meer geldig.

Voorbeeld:

```
<eb:MessageHeader eb:id="..." eb:version="2.0" SOAP:mustUnderstand="1">
  <eb:From>
    <eb:PartyId eb:type="IVB">10254</eb:PartyId>
    <eb:Role>http://www.edibulb.nl/roles/ivb</eb:Role>
  </eb:From>
  <eb:To>
    <eb:PartyId eb:type="Ontvanger">00000001</eb:PartyId>
    <eb:Role>http://www.edibulb.nl/roles/buyer</eb:Role>
  </eb:To>
  <eb:CPAId>http://www.edibulb.nl/cpa/123456</eb:CPAId>
  <eb:ConversationId>987654321</eb:ConversationId>
  <eb:Service eb:type="orderServices">Order</eb:Service>
  <eb:Action>ProcessOrder</eb:Action>
  <eb:MessageData>
    <eb:MessageId>UUID-2</eb:MessageId>
    <eb:Timestamp>2000-07-25T12:19:05</eb:Timestamp>
    <eb:RefToMessageId>UUID-1</eb:RefToMessageId>
  </eb:MessageData>
  <eb:DuplicateElimination/>
</eb:MessageHeader>
```

4.2.1.2 ebXML error

Het aanwezig zijn van een Errorlist element in de header, betekent dat het bericht wat geïdentificeerd is met het RefToMessageId, in de ebXML messageheader, een fout bevat welke op deze manier kenbaar wordt gemaakt.

De errorlist bevat de standaard SOAP attributen en één of meerdere error elementen. Het error-element bevat de volgende attributen:

- id = het id van het ebXML element dat de fout bevat.
- codeContext = verwijzing naar de error codelijst
- errorCode = foutcode
- severity = Warning (doorgaan) of Error (stoppen)
- location = foutlocatie als Xpointer naar het element die fout is, of als "cid" als het de inhoud van het bericht betreft, waarbij de "cid" het attachment aangeeft welke de fout bevat.

Daarnaast bevat het element één Description element welke een leesbare foutmelding bevat in de taal die is aangegeven in het xml:lang attribuut.

Voorbeeld:

```
<eb:ErrorList eb:id="3490sdo", eb:highestSeverity="error" eb:version="2.0" SOAP:mustUnderstand="1">
  <eb:Error eb:errorCode="SecurityFailure" eb:severity="Error"
    eb:location="URI of ds:Signature">
    <eb:Description xml:lang="en-US">Validation of signature failed</eb:Description>
  </eb:Error>
  <eb:Error ...> ... </eb:Error>
</eb:ErrorList>
```

4.2.2 SOAP Body

De body bevat minimaal het manifest welke de verwijzing(en) bevat naar de berichtinhoud.

4.2.2.1 ebXML manifest

Het manifest element bevat één of meerdere verwijzingen naar de meegezonden inhoudelijke attachement middels het Reference element, dit bevat de volgende onderdelen:

- Schema = nul of meerdere verwijzingen naar de schema's die de inhoud beschrijven.
- Description = nul of meerdere omschrijvingen van de inhoud.

Daarnaast wordt het attachement geïdentificeerd met de volgende attributen:

- id = identificatie van de referentie
- xlink:type = standaard ingevuld met 'simple'
- xlink:href = de URI naar het attachement met de inhoud.
- xlink:role = de rol van berichtinhoud als zijnde een verwijzing.

Voorbeeld:

```
<eb:Manifest eb:id="Manifest" eb:version="2.0">
  <eb:Reference eb:id="pay01"
    xlink:href="cid:payload-1"
    xlink:role="http://www.edibulb.nl/roles/Order">
    <eb:Schema eb:location="http://www.edibulb.nl/Order/Order-1_00.xsd" eb:version="1.0"/>
    <eb:Description xml:lang="NL">Order Message</eb:Description>
  </eb:Reference>
</eb:Manifest>
```

4.3 Beveiliging

Het bericht kan beveiligd getransporteerd worden middels s/mime. Dit dient echter door de ontvanger van het bericht ondersteund te worden.

5 Netwerk

De Logistieke Order berichten en de bevestiging op de Logistieke Order berichten zullen via het publieke internet worden getransporteerd middels e-mail..

Zie ook de technische afspraken op www.edibulb.nl

6 Bijlagen

6.1 Invulinstructie

Element	Component	C/M	Functioneel (logistiekeOrder)	Bestelling fust	Transportopdracht product (voorlopig)	Transportopdracht product (definitief)	Levering fust
logistiekeOrder							
header		M	Kop				
messageIdentifier	identificatie	M	Identificatie van het bericht				
messageDate	dateTime	M	Datum/tijd berichtgeneratie				
messageSerial	numeric	M	Berichtvolgnummer				
referenceDetails	reference	C	Referentie naar het berichtnummer van een logistieke order				
body		M	Details				
orderedBy	contact	M	Opdrachtgever				
partyDetails	party	M	Gegevens over de partij / contactpersoon				
contactAddress	postalAddress	M	Adres				
communicationDetails	communication	C	Telefoon, fax,				
referenceDetails	reference	C	Referentie van logistieke order uitgereikt door deze partij				
consignee	contact	C	Ontvanger				
partyDetails	party	C	Gegevens over de partij / contactpersoon				
contactAddress	postalAddress	C	Adres				
communicationDetails	communication	C	Telefoon, fax,				
referenceDetails	reference	C	Referentie van logistieke order uitgereikt door deze partij				
consignor	contact	C	Verzender				
partyDetails	party	C	Gegevens over de partij / contactpersoon				
contactAddress	postalAddress	C	Adres				
communicationDetails	communication	C	Telefoon, fax,				
referenceDetails	reference	C	Referentie van logistieke order uitgereikt door deze partij				
carrier	contact	M	Vervoerder				
partyDetails	party	M	Gegevens over de partij / contactpersoon				
contactAddress	postalAddress	M	Adres				
communicationDetails	communication	C	Telefoon, fax,				
referenceDetails	reference	C	Referentie van logistieke order uitgereikt door deze partij				
freightPayer	contact	M	Betaler van het transport				
partyDetails	party	M	Gegevens over de partij / contactpersoon				
contactAddress	postalAddress	M	Adres				
communicationDetails	communication	C	Telefoon, fax,				
referenceDetails	reference	C	Referentie van logistieke order uitgereikt door deze partij				
freeText	text	C 0..5	Vrije tekst				
lineItemDetails		M 1..∞	Detailregels (o.b.v. orderregels)				
lineNumber	identificatie	M	Regelnummer				
quantity	quantity	M	Hoeveelheid (bestellen / af te leveren)				
deliveredQuantity	quantity	C	Afgeleverde hoeveelheid				
toBeDeliveredQuantity	quantity	C	Nog af te leveren hoeveelheid				
kindOfDeliveryIndicator	indicator	C	Zending: Gehele partij / Gedeelde partij / Restpartij				
despatchDate	dateTime	C	Ophaaldatum/tijd				
despatchLocation	postalAddress	M	Ophaallocatie				
transshipmentLocation	postalAddress	M	Overslaglocatie				
deliveryDate	dateTime	M	Afleverdatum/tijd				
deliveryLocation	postalAddress	M	Afleverlocatie				
conditionCode	identificatie	C 0..∞	Transportcondities				
freeText	text	C 0..2	Vrije tekst				
palletDetails	packaging	M	Pallettype / hoeveelheid				
transportUnits		M 1..∞	Te transporteren eenheden				
packing	packing	M	Verpakkingseenheid				
packingDetails	packing	M	Verpakkingstype / hoeveelheid				
packingQuantity	quantity	C	Hoeveelheid per verpakkingstype (Inhoud)				
packingOwner	party	C	Eigenaar van de verpakking				
unitChargePrice	unitChargePrice	C	Prijs van de verpakking				
packingIndicator	indicator	C	Vol / Leeg / Gedeeltelijk gevuld				
markText	text	C	Merk / Opschrift / Code				
innerPackingQuantity	quantity	C	Hoeveelheid verpakkingseenheden op verpakkingseenheid				
packingID	identificatie	C	Unieke identificatie verpakkingseenheid				
orderInformation	orderInformation	C	Aanvullende informatie van order				
productCode	code	C	Product				
sizeCode	code	C	Afmeting				
orderedQuantity	quantity	C	Bestelde hoeveelheid				
transportCondition	measure	C 0..10	Transportcondities (temperatuur onder - bovengrens, relatieve vochtigheid,)				
referenceDetails	reference	C 0..∞	Referentie naar (voorgaande) gerelateerde berichten				
innerPacking	packing	C 0..∞	Beschrijving verpakking op verpakkingseenheid				
.....		C	idem packing				
Element	Component	C/M	Functioneel (logistiekeOrder)	Confirm	Confirm	Confirm	

■ Verplicht ■ Verplicht meerdere voorkomens M = Mandatory
■ Optioneel ■ Optioneel meerdere voorkomens C = Conditional
■ Niet gebruiken

6.2 Voorbeeld fust bestelopdracht

Bericht
Voorbeeld Fustbestelling: 150 dozen van het type 66
<pre><logistiekeOrder> <header> <messageIdentifier> <ebcc:content>0003046563</ebcc:content> <ebcc:schemelIdentifier>FB</ebcc:schemelIdentifier> <ebcc:schemeAgencyIdentifier>10253</ebcc:schemeAgencyIdentifier> <ebcc:schemeVersionIdentifier>LON10</ebcc:schemeVersionIdentifier> </messageIdentifier> <orderDate> <ebcc:content>20030101</ebcc:content> <ebcc:formatText>102</ebcc:formatText> </orderDate> <messageSerial> <ebcc:content>1</ebcc:content> </messageSerial> </header> <orderedBy> < dt:partyDetails> <ebcc:identifier><ebcc:content>09370</ebcc:content></ebcc:identifier> <ebcc:typeCode><ebcc:content>OB</ebcc:content></ebcc:typeCode> </ dt:partyDetails> <dt:contactAddress> <ebcc:streetBuildingIdentifier> <ebcc:content>4</ebcc:content> </ebcc:streetBuildingIdentifier> <ebcc:streetName> <ebcc:content>Hogeweg</ebcc:content> </ebcc:streetName> <ebcc:townName> <ebcc:content>Lisse</ebcc:content> </ebcc:townName> <ebcc:postCodeIdentifier> <ebcc:content>1234 AB</ebcc:content> </ebcc:postCodeIdentifier> <ebcc:countryCode><ebcc:content>NL</ebcc:content> </ebcc:countryCode> </dt:contactAddress> <dt:communicationDetails> <ebcc:modeCode> <ebcc:content>Tel</ebcc:content> </ebcc:modeCode> <ebcc:identifier> <ebcc:content>0505467182</ebcc:content> </ebcc:identifier> </dt:communicationDetails> </orderedBy> <carrier> . </carrier> <freightPayer> . </freightPayer> <lineItemDetails> <lineNumber> <ebcc:content>1</ebcc:content> </lineNumber> <quantity></pre>

```

    <ebcc:content>150</ebcc:content>
    <ebcc:unitCode>3</ebcc:unitCode>
  </quantity>
  <deliveryDate>
    <ebcc:content>200302011100</ebcc:content><ebcc:formatText>203</ebcc:formatText>
  </deliveryDate>
  <deliveryLocation>
    <ebcc:streetBuildingIdentifier>
      <ebcc:content>10</ebcc:content>
    </ebcc:streetBuildingIdentifier>
    <ebcc:streetName>
      <ebcc:content>Achterstraat</ebcc:content>
    </ebcc:streetName>
    <ebcc:townName>
      <ebcc:content>Lisse</ebcc:content>
    </ebcc:townName>
    <ebcc:countryCode>
      <ebcc:content>NLD</ebcc:content>
    </ebcc:countryCode>
    <ebcc:buildingIdentifier>
      <ebcc:content>3</ebcc:content>
    </ebcc:buildingIdentifier>
    <ebcc:buildingName>
      <ebcc:content>Koelcel</ebcc:content>
    </ebcc:buildingName>
  </deliveryLocation>
  <freeText>
    .
  </freeText>

  <transportUnits>
    <packing>
      <dt:packagingDetails>
        <ebcc:typeCode>
          <ebcc:content>66</ebcc:content>
        </ebcc:typeCode>
        <ebcc:objectCountValue>
          <ebcc:content>150</ebcc:content>
        </ebcc:objectCountValue>
      </dt:packagingDetails>
      <referenceDetails>
        <dt:referenceIdentifier>
          <ebcc:content>0003046562</ebcc:content>
          <ebcc:schemeIdentifier>ON</ebcc:schemeIdentifier>
          <ebcc:schemeAgencyIdentifier>10253</ebcc:schemeAgencyIdentifier>
          <ebcc:schemeVersionIdentifier>ORD13</ebcc:schemeVersionIdentifier>
        </dt:referenceIdentifier>
        <dt:lineNumber><ebcc:content>1</ebcc:content></dt:lineNumber>
      </referenceDetails>
    </packing>
  </transportUnits>

</lineItemDetails>
</logistiekeOrder>

```

6.3 Voorbeeld voorlopige goederen transportopdracht

Bericht

Voorbeeld Voorlopige goederen transportopdracht: 10 pallets met 50 dozen van het type 66

```
<logistiekeOrder>
  <header>
    <messageIdentifier>
      <ebcc:content>0003046570</ebcc:content>
      <ebcc:schemelIdentifier>VTO</ebcc:schemelIdentifier>
      <ebcc:schemeAgencyIdentifier>10253</ebcc:schemeAgencyIdentifier>
      <ebcc:schemeVersionIdentifier>LON10</ebcc:schemeVersionIdentifier>
    </messageIdentifier>
    <orderDate>
      <ebcc:content>20030101</ebcc:content>
      <ebcc:formatText>102</ebcc:formatText>
    </orderDate>
    <messageSerial>
      <ebcc:content>1</ebcc:content>
    </messageSerial>
  </header>
  <orderedBy>
    < dt:partyDetails>
      <ebcc:identifier><ebcc:content>09370</ebcc:content></ebcc:identifier>
      <ebcc:typeCode><ebcc:content>OB</ebcc:content></ebcc:typeCode>
    </ dt:partyDetails>
    <dt:contactAddress>
      <ebcc:streetBuildingIdentifier>
        <ebcc:content>4</ebcc:content>
      </ebcc:streetBuildingIdentifier>
      <ebcc:streetName>
        <ebcc:content>Hogeweg</ebcc:content>
      </ebcc:streetName>
      <ebcc:townName>
        <ebcc:content>Lisse</ebcc:content>
      </ebcc:townName>
      <ebcc:postCodeIdentifier>
        <ebcc:content>1234 AB</ebcc:content>
      </ebcc:postCodeIdentifier>
      <ebcc:countryCode><ebcc:content>NL</ebcc:content> </ebcc:countryCode>
    </dt:contactAddress>
    <dt:communicationDetails>
      <ebcc:modeCode>
        <ebcc:content>Tel</ebcc:content>
      </ebcc:modeCode>
      <ebcc:identifier>
        <ebcc:content>0505467182</ebcc:content>
      </ebcc:identifier>
    </dt:communicationDetails>
  </orderedBy>
  <carrier>
    .
  </carrier>
  <freightPayer>
    .
  </freightPayer>
  <lineItemDetails>
    <lineNumber>
      <ebcc:content>1</ebcc:content>
    </lineNumber>
    <quantity>
```

```

    <ebcc:content>10</ebcc:content>
    <ebcc:unitCode>45</ebcc:unitCode>
  </quantity>
  <despatchDate>
    <ebcc:content>200302010900</ebcc:content><ebcc:formatText>203</ebcc:formatText>
  </despatchDate>
  <despatchLocation>
    <ebcc:streetBuildingIdentifier>
      <ebcc:content>4</ebcc:content>
    </ebcc:streetBuildingIdentifier>
    <ebcc:streetName>
      <ebcc:content>Voorstraat</ebcc:content>
    </ebcc:streetName>
    <ebcc:townName>
      <ebcc:content>Lisse</ebcc:content>
    </ebcc:townName>
    <ebcc:countryCode>
      <ebcc:content>NLD</ebcc:content>
    </ebcc:countryCode>
    <ebcc:buildingIdentifier>
      <ebcc:content>1</ebcc:content>
    </ebcc:buildingIdentifier>
    <ebcc:buildingName>
      <ebcc:content>Loods</ebcc:content>
    </ebcc:buildingName>
  </despatchLocation>
  <deliveryDate>
    <ebcc:content>200302011100</ebcc:content><ebcc:formatText>203</ebcc:formatText>
  </deliveryDate>
  <deliveryLocation>
    <ebcc:streetBuildingIdentifier>
      <ebcc:content>10</ebcc:content>
    </ebcc:streetBuildingIdentifier>
    <ebcc:streetName>
      <ebcc:content>Achterstraat</ebcc:content>
    </ebcc:streetName>
    <ebcc:townName>
      <ebcc:content>Lisse</ebcc:content>
    </ebcc:townName>
    <ebcc:countryCode>
      <ebcc:content>NLD</ebcc:content>
    </ebcc:countryCode>
    <ebcc:buildingIdentifier>
      <ebcc:content>3</ebcc:content>
    </ebcc:buildingIdentifier>
    <ebcc:buildingName>
      <ebcc:content>Koelcel</ebcc:content>
    </ebcc:buildingName>
  </deliveryLocation>
  <conditionCode>
    <ebcc:content>388</ebcc:content>
  </conditionCode>
  <freeText>
    .
  </freeText>

  <transportUnits>
    <packing>
      <dt:packagingDetails>
        <ebcc:typeCode>
          <ebcc:content>73</ebcc:content>
        </ebcc:typeCode>
        <ebcc:objectCountValue>
          <ebcc:content>10</ebcc:content>
        </ebcc:objectCountValue>
      </dt:packagingDetails>
    </packing>
  </transportUnits>

```

```
<ebcc:content>5</ebcc:content>
<ebcc:unitCode>48</ebcc:unitCode>
</transportCondition>
<transportCondition>
  <ebcc:content>10</ebcc:content>
  <ebcc:unitCode>48</ebcc:unitCode>
</transportCondition>
<referenceDetails>
  <dt:referenceIdentifier>
    <ebcc:content>0003046573</ebcc:content>
    <ebcc:schemeIdentifier>ON</ebcc:schemeIdentifier>
    <ebcc:schemeAgencyIdentifier>10253</ebcc:schemeAgencyIdentifier>
    <ebcc:schemeVersionIdentifier>ORD13</ebcc:schemeVersionIdentifier>
  </dt:referenceIdentifier>
  <dt:lineNumber><ebcc:content>1</ebcc:content></dt:lineNumber>
</referenceDetails>
<dt:innerPackingQuantity>
  <ebcc:content>50</ebcc:content>
  <ebcc:unitCode>46</ebcc:unitCode>
</dt:innerPackingQuantity>
</packing>
</transportUnits>

</lineItemDetails>
</logistiekeOrder>
```

6.4 Voorbeeld definitieve goederen transportopdracht

6.4.1 Standaard

Bericht
Voorbeeld Definitieve goederen transportopdracht: 10 pallets met 50 dozen van het type 66
<pre><logistiekeOrder> <header> <messageIdentifier> <ebcc:content>0003046580</ebcc:content> <ebcc:schemelIdentifier>DTO</ebcc:schemelIdentifier> <ebcc:schemeAgencyIdentifier>10253</ebcc:schemeAgencyIdentifier> <ebcc:schemeVersionIdentifier>LON10</ebcc:schemeVersionIdentifier> </messageIdentifier> <orderDate> <ebcc:content>20030101</ebcc:content> <ebcc:formatText>102</ebcc:formatText> </orderDate> <messageSerial> <ebcc:content>1</ebcc:content> </messageSerial> </header> <orderedBy> < dt:partyDetails> <ebcc:identifier><ebcc:content>09370</ebcc:content></ebcc:identifier> <ebcc:typeCode><ebcc:content>OB</ebcc:content></ebcc:typeCode> </ dt:partyDetails> <dt:contactAddress> <ebcc:streetBuildingIdentifier> <ebcc:content>4</ebcc:content> </ebcc:streetBuildingIdentifier> <ebcc:streetName> <ebcc:content>Hogeweg</ebcc:content> </ebcc:streetName> <ebcc:townName> <ebcc:content>Lisse</ebcc:content> </ebcc:townName> <ebcc:postCodeIdentifier> <ebcc:content>1234 AB</ebcc:content> </ebcc:postCodeIdentifier> <ebcc:countryCode><ebcc:content>NL</ebcc:content> </ebcc:countryCode> </dt:contactAddress> <dt:communicationDetails> <ebcc:modeCode> <ebcc:content>Tel</ebcc:content> </ebcc:modeCode> <ebcc:identifier> <ebcc:content>0505467182</ebcc:content> </ebcc:identifier> </dt:communicationDetails> </orderedBy> <carrier> . </carrier> <freightPayer> . </freightPayer> . <lineItemDetails> <lineNumber> <ebcc:content>1</ebcc:content> </lineNumber> </lineItemDetails> </logistiekeOrder></pre>

```

</lineNumber>
<quantity>
  <ebcc:content>10</ebcc:content>
  <ebcc:unitCode>45</ebcc:unitCode>
</quantity>
<despatchDate>
  <ebcc:content>200302010900</ebcc:content><ebcc:formatText>203</ebcc:formatText>
</despatchDate>
<despatchLocation>
  <ebcc:streetBuildingIdentifier>
    <ebcc:content>4</ebcc:content>
  </ebcc:streetBuildingIdentifier>
  <ebcc:streetName>
    <ebcc:content>Voorstraat</ebcc:content>
  </ebcc:streetName>
  <ebcc:townName>
    <ebcc:content>Lisse</ebcc:content>
  </ebcc:townName>
  <ebcc:countryCode>
    <ebcc:content>NLD</ebcc:content>
  </ebcc:countryCode>
  <ebcc:buildingIdentifier>
    <ebcc:content>1</ebcc:content>
  </ebcc:buildingIdentifier>
  <ebcc:buildingName>
    <ebcc:content>Loods</ebcc:content>
  </ebcc:buildingName>
</despatchLocation>
<deliveryDate>
  <ebcc:content>200302011130</ebcc:content><ebcc:formatText>203</ebcc:formatText>
</deliveryDate>
<deliveryLocation>
  <ebcc:streetBuildingIdentifier>
    <ebcc:content>10</ebcc:content>
  </ebcc:streetBuildingIdentifier>
  <ebcc:streetName>
    <ebcc:content>Achterstraat</ebcc:content>
  </ebcc:streetName>
  <ebcc:townName>
    <ebcc:content>Lisse</ebcc:content>
  </ebcc:townName>
  <ebcc:countryCode>
    <ebcc:content>NLD</ebcc:content>
  </ebcc:countryCode>
  <ebcc:buildingIdentifier>
    <ebcc:content>3</ebcc:content>
  </ebcc:buildingIdentifier>
  <ebcc:buildingName>
    <ebcc:content>Koelcel</ebcc:content>
  </ebcc:buildingName>
</deliveryLocation>
<conditionCode>
  <ebcc:content>388</ebcc:content>
</conditionCode>
<freeText>
  .
  .
</freeText>

<transportUnits>
  <packing>
    <dt:packagingDetails>
      <ebcc:typeCode>
        <ebcc:content>73</ebcc:content>
      </ebcc:typeCode>
      <ebcc:objectCountValue>
        <ebcc:content>10</ebcc:content>
      </ebcc:objectCountValue>
    </dt:packagingDetails>
  </packing>
</transportUnits>

```

```
</dt:packagingDetails>
<dt:orderInformation>
  <dt:productCode>
    <ebcc:content>9839</ebcc:content>
  </dt:productCode>
  <dt:sizeCode>
    <ebcc:content>867</ebcc:content>
  </dt:sizeCode>
  <dt:orderedQuantity>
    <ebcc:content>25000</ebcc:content>
    <ebcc:unitCode>11</ebcc:unitCode>
  </dt:orderedQuantity>
</dt:orderInformation>
<transportCondition>
  <ebcc:content>5</ebcc:content>
  <ebcc:unitCode>48</ebcc:unitCode>
</transportCondition>
<transportCondition>
  <ebcc:content>10</ebcc:content>
  <ebcc:unitCode>48</ebcc:unitCode>
</transportCondition>
<referenceDetails>
  <dt:referenceIdentifier>
    <ebcc:content>0003046573</ebcc:content>
    <ebcc:schemeIdentifier>ON</ebcc:schemeIdentifier>
    <ebcc:schemeAgencyIdentifier>10253</ebcc:schemeAgencyIdentifier>
    <ebcc:schemeVersionIdentifier>ORD13</ebcc:schemeVersionIdentifier>
  </dt:referenceIdentifier>
  <dt:lineNumber><ebcc:content>1</ebcc:content></dt:lineNumber>
</referenceDetails>
  <dt:innerPackingQuantity>
    <ebcc:content>50</ebcc:content>
    <ebcc:unitCode>46</ebcc:unitCode>
  </dt:innerPackingQuantity>
</packing>
</transportUnits>

</linelItemDetails>
</logistiekeOrder>
```

6.4.2 Voorbeelden detaillering definitieve goederen transportopdracht

In de volgende paragrafen worden een paar voorbeelden van de invulling van het transportUnit deel voor een definitieve transportopdracht uitgewerkt (alleen de relevante delen).

De voorbeelden zijn gebaseerd op een order van 32 stuks dozen (inhoud 10 kg) op 3 pallets met 10 dozen en 1 pallet met 2 dozen.

Elke pallet en doos heeft een uniek identificatienummer (zie tekening).

33	18	22	25	44	4	69	102	88			
50	83	73	101	51	86	105	99	45	9	89	103
45	65	11	10	13	66	8	107	3	77	112	
2501			2410			2755			2356		

6.4.2.1 Voorbeeld 1 - Basis

Bericht

Voorbeeld 1 DTO: 3 pallets geheel gevuld (10 dozen) en 1 pallet gedeeltelijk gevuld (2 dozen)

```
<logistiekeOrder>
```

```
  .
  .
  .
  .
```

```
  <lineltemDetails>
```

```
    <lineNumber>
```

```
      <ebcc:content>1</ebcc:content>
```

```
    </lineNumber>
```

```
    <quantity>
```

```
      <ebcc:content>4</ebcc:content>
```

```
      <ebcc:unitCode>45</ebcc:unitCode>
```

```
    </quantity>
```

```
    .
    .
    .
    .
```

```
  <freeText>
```

```
    .
    .
```

```
  </freeText>
```

```
  <transportUnits>
```

```
    <packing>
```

```
      <dt:packagingDetails>
```

```
        <ebcc:typeCode>
```

```
          <ebcc:content>73</ebcc:content>
```

```
        </ebcc:typeCode>
```

```
        <ebcc:objectCountValue>
```

```
          <ebcc:content>3</ebcc:content>
```

```
        </ebcc:objectCountValue>
```

```
      </dt:packagingDetails>
```

```
      <dt:packagingIndicator>
```

```
        <ebcc:content>5</ebcc:content>
```

```
      </dt:packagingIndicator>
```

```
      <dt:innerPackingQuantity>
```

```
        <ebcc:content>10</ebcc:content>
        <ebcc:unitCode>46</ebcc:unitCode>
      </dt:innerPackingQuantity>
    </packing>
  </transportUnits>

  <transportUnits>
    <packing>
      <dt:packagingDetails>
        <ebcc:typeCode>
          <ebcc:content>73</ebcc:content>
        </ebcc:typeCode>
        <ebcc:objectCountValue>
          <ebcc:content>1</ebcc:content>
        </ebcc:objectCountValue>
      </dt:packagingDetails>
      <dt:packagingIndicator>
        <ebcc:content>7</ebcc:content>
      </dt:packagingIndicator>
      <dt:innerPackingQuantity>
        <ebcc:content>2</ebcc:content>
        <ebcc:unitCode>46</ebcc:unitCode>
      </dt:innerPackingQuantity>
    </packing>
  </transportUnits>

</lineltemDetails>
</logistiekeOrder>
```

6.4.2.2 Voorbeeld 2 - Met ladingdrager identificatie**Bericht**

Voorbeeld 2 DTO: 1 pallet geheel gevuld (10 dozen) en ID 2501, 1 pallet geheel gevuld (10 dozen) en ID 2410, 1 pallet geheel gevuld (10 dozen) en ID 2755 en 1 pallet gedeeltelijk gevuld (2 dozen) en ID 2356

```

<logistiekeOrder>
  .
  .
  .
  .
  <lineltemDetails>
    <lineNumber>
      <ebcc:content>1</ebcc:content>
    </lineNumber>

    <quantity>
      <ebcc:content>4</ebcc:content>
      <ebcc:unitCode>45</ebcc:unitCode>
    </quantity>
    .
    .
    .
  </lineltemDetails>

  <freeText>
    .
  </freeText>

  <transportUnits>
    <packing>
      <dt:packagingDetails>
        <ebcc:typeCode>
          <ebcc:content>73</ebcc:content>
        </ebcc:typeCode>
        <ebcc:objectCountValue>
          <ebcc:content>1</ebcc:content>
        </ebcc:objectCountValue>
      </dt:packagingDetails>
      <dt:packagingIndicator>
        <ebcc:content>5</ebcc:content>
      </dt:packagingIndicator>
      <dt:innerPackingQuantity>
        <ebcc:content>10</ebcc:content>
        <ebcc:unitCode>46</ebcc:unitCode>
      </dt:innerPackingQuantity>
      <dt:packagingID>
        <ebcc:content>2501</ebcc:content>
      </dt:packagingID>
    </packing>
  </transportUnits>

  <transportUnits>
    <packing>
      <dt:packagingDetails>
        <ebcc:typeCode>
          <ebcc:content>73</ebcc:content>
        </ebcc:typeCode>
        <ebcc:objectCountValue>
          <ebcc:content>1</ebcc:content>
        </ebcc:objectCountValue>
      </dt:packagingDetails>
      <dt:packagingIndicator>
        <ebcc:content>5</ebcc:content>
      </dt:packagingIndicator>
      <dt:innerPackingQuantity>

```

```

        <ebcc:content>10</ebcc:content>
        <ebcc:unitCode>46</ebcc:unitCode>
      </dt:innerPackingQuantity>
      <dt:packagingID>
        <ebcc:content>2410</ebcc:content>
      </dt:packagingID>
    </packing>
  </transportUnits>

  <transportUnits>
    <packing>
      <dt:packagingDetails>
        <ebcc:typeCode>
          <ebcc:content>73</ebcc:content>
        </ebcc:typeCode>
        <ebcc:objectCountValue>
          <ebcc:content>1</ebcc:content>
        </ebcc:objectCountValue>
      </dt:packagingDetails>
      <dt:packagingIndicator>
        <ebcc:content>5</ebcc:content>
      </dt:packagingIndicator>
      <dt:innerPackingQuantity>
        <ebcc:content>10</ebcc:content>
        <ebcc:unitCode>46</ebcc:unitCode>
      </dt:innerPackingQuantity>
      <dt:packagingID>
        <ebcc:content>2755</ebcc:content>
      </dt:packagingID>
    </packing>
  </transportUnits>

  <transportUnits>
    <packing>
      <dt:packagingDetails>
        <ebcc:typeCode>
          <ebcc:content>73</ebcc:content>
        </ebcc:typeCode>
        <ebcc:objectCountValue>
          <ebcc:content>1</ebcc:content>
        </ebcc:objectCountValue>
      </dt:packagingDetails>
      <dt:packagingIndicator>
        <ebcc:content>7</ebcc:content>
      </dt:packagingIndicator>
      <dt:innerPackingQuantity>
        <ebcc:content>2</ebcc:content>
        <ebcc:unitCode>46</ebcc:unitCode>
      </dt:innerPackingQuantity>
      <dt:packagingID>
        <ebcc:content>2356</ebcc:content>
      </dt:packagingID>
    </packing>
  </transportUnits>

</linelItemDetails>
</logistiekeOrder>

```

6.4.2.3 Voorbeeld 3 - Met fustspecificatie**Bericht**

Voorbeeld 3 DTO: 1 pallet geheel gevuld (10 dozen type 66 inhoud 10) en ID 2501, 1 pallet geheel gevuld (10 dozen type 66 inhoud 10) en ID 2410, 1 pallet geheel gevuld (10 dozen type 66 inhoud 10) en ID 2755 en 1 pallet gedeeltelijk gevuld (2 dozen type 66 inhoud 10) en ID 2356

```

<logistiekeOrder>
  .
  .
  .
  <lineltemDetails>
    <lineNumber>
      <ebcc:content>1</ebcc:content>
    </lineNumber>

    <quantity>
      <ebcc:content>4</ebcc:content>
      <ebcc:unitCode>45</ebcc:unitCode>
    </quantity>
    .
    .
    .
    <freeText>
      .
      .
    </freeText>

    <transportUnits>
      <packing>
        <dt:packagingDetails>
          <ebcc:typeCode>
            <ebcc:content>73</ebcc:content>
          </ebcc:typeCode>
          <ebcc:objectCountValue>
            <ebcc:content>1</ebcc:content>
          </ebcc:objectCountValue>
        </dt:packagingDetails>
        <dt:packagingIndicator>
          <ebcc:content>5</ebcc:content>
        </dt:packagingIndicator>

        <dt:innerPacking>
          <dt:packagingDetails>
            <ebcc:typeCode>
              <ebcc:content>66</ebcc:content>
            </ebcc:typeCode>
            <ebcc:objectCountValue>
              <ebcc:content>10</ebcc:content>
            </ebcc:objectCountValue>
          </dt:packagingDetails>
          <dt:packagingQuantity>
            <ebcc:content>10</ebcc:content>
          </dt:packagingQuantity>
          <dt:packagingIndicator>
            <ebcc:content>5</ebcc:content>
          </dt:packagingIndicator>
        </dt:innerPacking>

        <dt:packagingID>
          <ebcc:content>2501</ebcc:content>
        </dt:packagingID>
      </packing>
    </transportUnits>
  
```

```

<transportUnits>
  <packing>
    <dt:packagingDetails>
      <ebcc:typeCode>
        <ebcc:content>73</ebcc:content>
      </ebcc:typeCode>
      <ebcc:objectCountValue>
        <ebcc:content>1</ebcc:content>
      </ebcc:objectCountValue>
    </dt:packagingDetails>
    <dt:packagingIndicator>
      <ebcc:content>5</ebcc:content>
    </dt:packagingIndicator>

    <dt:innerPacking>
      <dt:packagingDetails>
        <ebcc:typeCode>
          <ebcc:content>66</ebcc:content>
        </ebcc:typeCode>
        <ebcc:objectCountValue>
          <ebcc:content>10</ebcc:content>
        </ebcc:objectCountValue>
      </dt:packagingDetails>
      <dt:packagingQuantity>
        <ebcc:content>10</ebcc:content>
      </dt:packagingQuantity>
      <dt:packagingIndicator>
        <ebcc:content>5</ebcc:content>
      </dt:packagingIndicator>
    </dt:innerPacking>

    <dt:packagingID>
      <ebcc:content>2410</ebcc:content>
    </dt:packagingID>
  </packing>
</transportUnits>

<transportUnits>
  <packing>
    <dt:packagingDetails>
      <ebcc:typeCode>
        <ebcc:content>73</ebcc:content>
      </ebcc:typeCode>
      <ebcc:objectCountValue>
        <ebcc:content>1</ebcc:content>
      </ebcc:objectCountValue>
    </dt:packagingDetails>
    <dt:packagingIndicator>
      <ebcc:content>5</ebcc:content>
    </dt:packagingIndicator>

    <dt:innerPacking>
      <dt:packagingDetails>
        <ebcc:typeCode>
          <ebcc:content>66</ebcc:content>
        </ebcc:typeCode>
        <ebcc:objectCountValue>
          <ebcc:content>10</ebcc:content>
        </ebcc:objectCountValue>
      </dt:packagingDetails>
      <dt:packagingQuantity>
        <ebcc:content>10</ebcc:content>
      </dt:packagingQuantity>
      <dt:packagingIndicator>
        <ebcc:content>5</ebcc:content>
      </dt:packagingIndicator>
    </dt:innerPacking>
  </packing>
</transportUnits>

```

```
<dt:packagingID>
  <ebcc:content>2755</ebcc:content>
</dt:packagingID>
</packing>
</transportUnits>

<transportUnits>
  <packing>
    <dt:packagingDetails>
      <ebcc:typeCode>
        <ebcc:content>73</ebcc:content>
      </ebcc:typeCode>
      <ebcc:objectCountValue>
        <ebcc:content>1</ebcc:content>
      </ebcc:objectCountValue>
    </dt:packagingDetails>
    <dt:packagingIndicator>
      <ebcc:content>7</ebcc:content>
    </dt:packagingIndicator>

    <dt:innerPacking>
      <dt:packagingDetails>
        <ebcc:typeCode>
          <ebcc:content>66</ebcc:content>
        </ebcc:typeCode>
        <ebcc:objectCountValue>
          <ebcc:content>2</ebcc:content>
        </ebcc:objectCountValue>
      </dt:packagingDetails>
      <dt:packagingQuantity>
        <ebcc:content>10</ebcc:content>
      </dt:packagingQuantity>
      <dt:packagingIndicator>
        <ebcc:content>5</ebcc:content>
      </dt:packagingIndicator>
    </dt:innerPacking>

    <dt:packagingID>
      <ebcc:content>2356</ebcc:content>
    </dt:packagingID>
  </packing>
</transportUnits>

</lineItemDetails>
</logistiekeOrder>
```

6.4.2.4 Voorbeeld 4 - Met individuele fust identificatie**Bericht**

Voorbeeld 4 DTO: 1 pallet met ID 2501 geheel gevuld met 1 doos type 66 inhoud 10 ID 45, 1 doos type 66 inhoud 10 met ID 65,, 1 doos type 66 inhoud 10 met ID 22, 1 pallet met ID 2410 geheel gevuld met 1 doos type 66 inhoud 10 ID 10,, 1 pallet met ID 2755 geheel gevuld met 1 doos type 66 inhoud 10 ID 8,, en 1 pallet met ID 2356 gedeeltelijk gevuld met 1 doos type 66 inhoud 10 ID 77 en 1 doos type 66 inhoud 10 ID 122

```
<logistiekeOrder>
```

```
  .
  .
  .
  .
```

```
  <lineltemDetails>
```

```
    <lineNumber>
```

```
      <ebcc:content>1</ebcc:content>
```

```
    </lineNumber>
```

```
    <quantity>
```

```
      <ebcc:content>4</ebcc:content>
```

```
      <ebcc:unitCode>45</ebcc:unitCode>
```

```
    </quantity>
```

```
    .
    .
    .
    .
```

```
  <freeText>
```

```
    .
    .
```

```
  </freeText>
```

```
  <transportUnits>
```

```
    <packing>
```

```
      <dt:packagingDetails>
```

```
        <ebcc:typeCode>
```

```
          <ebcc:content>73</ebcc:content>
```

```
        </ebcc:typeCode>
```

```
        <ebcc:objectCountValue>
```

```
          <ebcc:content>1</ebcc:content>
```

```
        </ebcc:objectCountValue>
```

```
      </dt:packagingDetails>
```

```
      <dt:packagingIndicator>
```

```
        <ebcc:content>5</ebcc:content>
```

```
      </dt:packagingIndicator>
```

```
      <dt:innerPacking>
```

```
        <dt:packagingDetails>
```

```
          <ebcc:typeCode>
```

```
            <ebcc:content>66</ebcc:content>
```

```
          </ebcc:typeCode>
```

```
          <ebcc:objectCountValue>
```

```
            <ebcc:content>1</ebcc:content>
```

```
          </ebcc:objectCountValue>
```

```
        </dt:packagingDetails>
```

```
        <dt:packagingQuantity>
```

```
          <ebcc:content>10</ebcc:content>
```

```
        </dt:packagingQuantity>
```

```
        <dt:packagingIndicator>
```

```
          <ebcc:content>5</ebcc:content>
```

```
        </dt:packagingIndicator>
```

```
        <dt:packagingID>
```

```
          <ebcc:content>45</ebcc:content>
```

```
        </dt:packagingID>
```

```
      </dt:innerPacking>
```

```

<dt:innerPacking>
  <dt:packagingDetails>
    <ebcc:typeCode>
      <ebcc:content>66</ebcc:content>
    </ebcc:typeCode>
    <ebcc:objectCountValue>
      <ebcc:content>1</ebcc:content>
    </ebcc:objectCountValue>
  </dt:packagingDetails>
  <dt:packagingQuantity>
    <ebcc:content>10</ebcc:content>
  </dt:packagingQuantity>
  <dt:packagingIndicator>
    <ebcc:content>5</ebcc:content>
  </dt:packagingIndicator>
  <dt:packagingID>
    <ebcc:content>65</ebcc:content>
  </dt:packagingID>
</dt:innerPacking>

.
.
.
.

<dt:innerPacking>
  <dt:packagingDetails>
    <ebcc:typeCode>
      <ebcc:content>66</ebcc:content>
    </ebcc:typeCode>
    <ebcc:objectCountValue>
      <ebcc:content>1</ebcc:content>
    </ebcc:objectCountValue>
  </dt:packagingDetails>
  <dt:packagingQuantity>
    <ebcc:content>10</ebcc:content>
  </dt:packagingQuantity>
  <dt:packagingIndicator>
    <ebcc:content>5</ebcc:content>
  </dt:packagingIndicator>
  <dt:packagingID>
    <ebcc:content>22</ebcc:content>
  </dt:packagingID>
</dt:innerPacking>

<dt:packagingID>
  <ebcc:content>2501</ebcc:content>
</dt:packagingID>
</packing>
</transportUnits>

<transportUnits>
  <packing>
    <dt:packagingDetails>
      <ebcc:typeCode>
        <ebcc:content>73</ebcc:content>
      </ebcc:typeCode>
      <ebcc:objectCountValue>
        <ebcc:content>1</ebcc:content>
      </ebcc:objectCountValue>
    </dt:packagingDetails>
    <dt:packagingIndicator>
      <ebcc:content>5</ebcc:content>
    </dt:packagingIndicator>

    <dt:innerPacking>
      <dt:packagingDetails>
        <ebcc:typeCode>
          <ebcc:content>66</ebcc:content>
        </ebcc:typeCode>
      </dt:packagingDetails>
    </dt:innerPacking>
  </packing>
</transportUnits>

```

```

        </ebcc:typeCode>
        <ebcc:objectCountValue>
          <ebcc:content>1</ebcc:content>
        </ebcc:objectCountValue>
      </dt:packagingDetails>
      <dt:packagingQuantity>
        <ebcc:content>10</ebcc:content>
      </dt:packagingQuantity>
      <dt:packagingIndicator>
        <ebcc:content>5</ebcc:content>
      </dt:packagingIndicator>
      <dt:packagingID>
        <ebcc:content>10</ebcc:content>
      </dt:packagingID>
    </dt:innerPacking>
  </transportUnits>
  .
  .
  .
  .
  <dt:packagingID>
    <ebcc:content>2410</ebcc:content>
  </dt:packagingID>
</packing>
</transportUnits>
<transportUnits>
  <packing>
    <dt:packagingDetails>
      <ebcc:typeCode>
        <ebcc:content>73</ebcc:content>
      </ebcc:typeCode>
      <ebcc:objectCountValue>
        <ebcc:content>1</ebcc:content>
      </ebcc:objectCountValue>
    </dt:packagingDetails>
    <dt:packagingIndicator>
      <ebcc:content>5</ebcc:content>
    </dt:packagingIndicator>
  </dt:innerPacking>
    <dt:packagingDetails>
      <ebcc:typeCode>
        <ebcc:content>66</ebcc:content>
      </ebcc:typeCode>
      <ebcc:objectCountValue>
        <ebcc:content>1</ebcc:content>
      </ebcc:objectCountValue>
    </dt:packagingDetails>
    <dt:packagingQuantity>
      <ebcc:content>10</ebcc:content>
    </dt:packagingQuantity>
    <dt:packagingIndicator>
      <ebcc:content>5</ebcc:content>
    </dt:packagingIndicator>
    <dt:packagingID>
      <ebcc:content>8</ebcc:content>
    </dt:packagingID>
  </dt:innerPacking>
  .
  .
  .
  .
  <dt:packagingID>
    <ebcc:content>2755</ebcc:content>
  </dt:packagingID>

```

```

</packing>
</transportUnits>

<transportUnits>
  <packing>
    <dt:packagingDetails>
      <ebcc:typeCode>
        <ebcc:content>73</ebcc:content>
      </ebcc:typeCode>
      <ebcc:objectCountValue>
        <ebcc:content>1</ebcc:content>
      </ebcc:objectCountValue>
    </dt:packagingDetails>
    <dt:packagingIndicator>
      <ebcc:content>7</ebcc:content>
    </dt:packagingIndicator>

    <dt:innerPacking>
      <dt:packagingDetails>
        <ebcc:typeCode>
          <ebcc:content>66</ebcc:content>
        </ebcc:typeCode>
        <ebcc:objectCountValue>
          <ebcc:content>1</ebcc:content>
        </ebcc:objectCountValue>
      </dt:packagingDetails>
      <dt:packagingQuantity>
        <ebcc:content>10</ebcc:content>
      </dt:packagingQuantity>
      <dt:packagingIndicator>
        <ebcc:content>5</ebcc:content>
      </dt:packagingIndicator>
      <dt:packagingID>
        <ebcc:content>77</ebcc:content>
      </dt:packagingID>
    </dt:innerPacking>

    <dt:innerPacking>
      <dt:packagingDetails>
        <ebcc:typeCode>
          <ebcc:content>66</ebcc:content>
        </ebcc:typeCode>
        <ebcc:objectCountValue>
          <ebcc:content>1</ebcc:content>
        </ebcc:objectCountValue>
      </dt:packagingDetails>
      <dt:packagingQuantity>
        <ebcc:content>10</ebcc:content>
      </dt:packagingQuantity>
      <dt:packagingIndicator>
        <ebcc:content>5</ebcc:content>
      </dt:packagingIndicator>
      <dt:packagingID>
        <ebcc:content>112</ebcc:content>
      </dt:packagingID>
    </dt:innerPacking>

    <dt:packagingID>
      <ebcc:content>2356</ebcc:content>
    </dt:packagingID>
  </packing>
</transportUnits>

</linelItemDetails>
</logistiekeOrder>

```

6.5 Voorbeeld fust levering

Bericht

Voorbeeld Fustlevering: zending van 100 dozen van het type 66; 50 worden nog nageleverd

```
<logistiekeOrder>
  <header>
    <messageIdentifier>
      <ebcc:content>000304208</ebcc:content>
      <ebcc:schemelIdentifier>FL</ebcc:schemelIdentifier>
      <ebcc:schemeAgencyIdentifier>10253</ebcc:schemeAgencyIdentifier>
      <ebcc:schemeVersionIdentifier>LON10</ebcc:schemeVersionIdentifier>
    </messageIdentifier>
    <orderDate>
      <ebcc:content>20030101</ebcc:content>
      <ebcc:formatText>102</ebcc:formatText>
    </orderDate>
    <messageSerial>
      <ebcc:content>1</ebcc:content>
    </messageSerial>
  </header>
  <orderedBy>
    < dt:partyDetails>
      <ebcc:identifier><ebcc:content>09370</ebcc:content></ebcc:identifier>
      <ebcc:typeCode><ebcc:content>OB</ebcc:content></ebcc:typeCode>
    </ dt:partyDetails>
    <dt:contactAddress>
      <ebcc:streetBuildingIdentifier>
        <ebcc:content>4</ebcc:content>
      </ebcc:streetBuildingIdentifier>
      <ebcc:streetName>
        <ebcc:content>Hogeweg</ebcc:content>
      </ebcc:streetName>
      <ebcc:townName>
        <ebcc:content>Lisse</ebcc:content>
      </ebcc:townName>
      <ebcc:postCodeIdentifier>
        <ebcc:content>1234 AB</ebcc:content>
      </ebcc:postCodeIdentifier>
      <ebcc:countryCode><ebcc:content>NL</ebcc:content> </ebcc:countryCode>
    </dt:contactAddress>
    <dt:communicationDetails>
      <ebcc:modeCode>
        <ebcc:content>Tel</ebcc:content>
      </ebcc:modeCode>
      <ebcc:identifier>
        <ebcc:content>0505467182</ebcc:content>
      </ebcc:identifier>
    </dt:communicationDetails>
  </orderedBy>
  <consignee>
    .
  </consignee>
  <consignor>
    .
  </consignor>
  <carrier>
    .
  </carrier>
  <freightPayer>
    .
  </freightPayer>
```

```

</freightPayer>
.
.
<lineltemDetails>
  <lineNumber>
    <ebcc:content>1</ebcc:content>
  </lineNumber>
  <quantity>
    <ebcc:content>100</ebcc:content>
    <ebcc:unitCode>3</ebcc:unitCode>
  </quantity>
  <toBeDeliveredQuantity>
    <ebcc:content>50</ebcc:content>
    <ebcc:unitCode>3</ebcc:unitCode>
  </toBeDeliveredQuantity>
  <kindOfDeliveryIndicator>
    <ebcc:content>3</ebcc:content>
  </kindOfDeliveryIndicator>
  <deliveryDate>
    <ebcc:content>200302011100</ebcc:content><ebcc:formatText>203</ebcc:formatText>
  </deliveryDate>
  <deliveryLocation>
    <ebcc:streetBuildingIdentifier><ebcc:content>10</ebcc:content></ebcc:streetBuildingIdentifier>
    <ebcc:streetName><ebcc:content>Achterstraat</ebcc:content></ebcc:streetName>
    <ebcc:townName><ebcc:content>Lisse</ebcc:content></ebcc:townName>
    <ebcc:countryCode><ebcc:content>NLD</ebcc:content></ebcc:countryCode>
    <ebcc:buildingIdentifier><ebcc:content>3</ebcc:content></ebcc:buildingIdentifier>
    <ebcc:buildingName><ebcc:content>Koelcel</ebcc:content></ebcc:buildingName>
  </deliveryLocation>
  <freeText>
    .
    .
  </freeText>
</lineltemDetails>
<transportUnits>
  <packing>
    <dt:packagingDetails>
      <ebcc:typeCode>
        <ebcc:content>66</ebcc:content>
      </ebcc:typeCode>
      <ebcc:objectCountValue>
        <ebcc:content>100</ebcc:content>
      </ebcc:objectCountValue>
    </dt:packagingDetails>
    <referenceDetails>
      <dt:referenceIdentifier>
        <ebcc:content>0003046562</ebcc:content>
        <ebcc:schemeIdentifier>ON</ebcc:schemeIdentifier>
        <ebcc:schemeAgencyIdentifier>10253</ebcc:schemeAgencyIdentifier>
        <ebcc:schemeVersionIdentifier>ORD13</ebcc:schemeVersionIdentifier>
      </dt:referenceIdentifier>
      <dt:lineNumber><ebcc:content>1</ebcc:content></dt:lineNumber>
    </referenceDetails>
    <referenceDetails>
      <dt:referenceIdentifier>
        <ebcc:content>0003046563</ebcc:content>
        <ebcc:schemeIdentifier>FB</ebcc:schemeIdentifier>
        <ebcc:schemeAgencyIdentifier>10253</ebcc:schemeAgencyIdentifier>
        <ebcc:schemeVersionIdentifier>LON10</ebcc:schemeVersionIdentifier>
      </dt:referenceIdentifier>
    </referenceDetails>
  </packing>
</transportUnits>
</lineltemDetails>
</logistiekeOrder>

```